



PARTS LIST FOR
AIR COMPRESSOR
AM2-PH09-08M/20M/30M
AM2-PR09-08M/20M/30M
AM2-PK95-08M
AM2-SH09-20M/30M
AM2-SR09-20M/30M
AM2-SH09-B

ENGINE OIL GRADE:	SAE 10W-30
ENGINE OIL CAPACITY	
HONDA:	37 oz.
KOHLER:	44.8 oz.
SUBARU:	35.5 oz.
MAXIMUM PRESSURE:	175 PSI
COMPRESSOR OIL GRADE:	SAE30W NON-DETERGENT
COMPRESSOR OIL CAPACITY:	24.7 oz.

This Parts Listing has been compiled for your benefit. You can be assured your Mi-T-M Gasoline Air Compressor was constructed and designed with quality and performance in mind. Each component has been rigorously tested to insure the highest level of acceptance.

The contents of this Parts Listing are based on the latest product information available at the time of publication. Mi-T-M reserves the right to make changes in price, color, materials, equipment, specifications or models at any time without notice.

WARNING

THIS IS A PROFESSIONAL GASOLINE AIR COMPRESSOR. CAUTION SHOULD BE OBSERVED WHEN USING OR REPAIRING THIS UNIT! READ AND FOLLOW THE SAFETY WARNINGS LISTED BELOW BEFORE ATTEMPTING ANY REPAIRS ON THIS GASOLINE AIR COMPRESSOR!

SAFETY WARNINGS

1. NEVER alter or modify the equipment. Be sure any accessory items and system components being used will withstand the pressure developed. Serious injury may occur from an air compressor malfunction or exploding accessories if incorrect system components, attachments or accessories are used. NEVER exceed manufactures maximum allowable pressure rating of attachments. Use only genuine Mi-T-M parts for repair of your air compressor. Failure to do so can cause hazardous operating conditions and will VOID warranty.
2. NEVER make adjustments on machinery while the unit is connected to the engine without first removing the ignition cable from the spark plug. Turning over the machinery by hand during adjustment or cleaning might start the engine and machinery with it, causing serious injury to the operator.
3. Know how to stop and bleed pressures quickly. Be thoroughly familiar with controls. Do not operate without protective covers/ guards.
4. Before servicing the unit, turn unit off, relieve the pressure and allow the unit to cool down. Service in a clean, dry, flat area. Block the wheels to prevent the unit from moving. Be especially careful to properly dispose of any flammable materials.
5. After testing the machine, DO NOT leave the pressurized unit unattended. Shut off the unit and release pressure before leaving.

Table of Contents

SPECIFICATIONS.....	3
FLOW CHART	4
GENERAL THEORY OF OPERATION	5
TANK ASSEMBLY FOR AM2-PH09-08M	6
TANK ASSEMBLY FOR AM2-PH09-20M	8
TANK ASSEMBLY FOR AM2-PH09-30M	10
TANK ASSEMBLY FOR AM2-PK95_PR09-08M	12
TANK ASSEMBLY FOR AM2-PR09-20M	14
TANK ASSEMBLY FOR AM2-PR09-30M	16
TANK ASSEMBLY FOR AM2-SH09-20M	18
TANK ASSEMBLY FOR AM2-SH09-30M	20
TANK ASSEMBLY FOR AM2-SR09-20M	22
TANK ASSEMBLY FOR AM2-SR09-30M	24
BASE MOUNT ASSEMBLY FOR AM2-SH09-B.....	26
TWO STAGE COMPRESSOR (3-0298)	28
PILOT VALVE (22-0270).....	30

SPECIFICATIONS

MODEL NUMBER	AM2-(PH09, PR09, PK95)-08M	AM2-(PH09, PR09)-20M	AM2-(PH09, PR09)-30M	AM2-(SH09, SR09)-20M	AM2-(SH09, SR09)-30M	AM2-SH09-B
Engine:						
Model	GX270 / EX27 / CH395	GX270 / EX27	GX270 / EX27	GX270 / EX27	GX270 / EX27	GX270
Engine Type	4 stroke, overhead valve, single cylinder (Honda, Kohler) / 4 stroke, overhead cam, single cylinder (Subaru)					
Oil Type	SAE 10W-30					
Oil Capacity	37 oz. / 35.5 oz. / 44.8 oz.	37 oz. / 35.5 oz.	37 oz. / 35.5 oz.	37 oz. / 35.5 oz.	37 oz. / 35.5 oz.	37 oz.
Low Oil Protection	Oil Alert™ / Oil Sensor / Oil Sentry™	Oil Alert™ / Oil Sensor	Oil Alert™ / Oil Sensor	Oil Alert™ / Oil Sensor	Oil Alert™ / Oil Sensor	Oil Alert™
Fuel Type	Unleaded Gasoline 86 Octane Minimum					
Fuel Capacity	1.4 Gallon / 1.6 Gallon / 1.8 Gallon	1.4 Gallon / 1.6 Gallon	1.4 Gallon / 1.6 Gallon	1.4 Gallon / 1.6 Gallon	1.4 Gallon / 1.6 Gallon	1.4 Gallon
Starting	Recoil	Recoil	Recoil	Recoil	Recoil	Recoil
Engine RPM	3500	3500	3500	3500	3500	3500
Idle RPM	2200-2400	2200-2400	2200-2400	2200-2400	2200-2400	2200-2400
Compressor Pump:						
Number of Cylinders	2	2	2	2	2	2
Compression Stages	2	2	2	2	2	2
First Stage Bore	3.94"	3.94"	3.94"	3.94"	3.94"	3.94"
Second Stage Bore	2.17"	2.17"	2.17"	2.17"	2.17"	2.17"
Stroke	3.36"	3.36"	3.36"	3.36"	3.36"	3.36"
RPM	864	864	864	864	864	864
Flywheel	16.5"	16.5"	16.5"	16.5"	16.5"	16.5"
Lubrication	Splash	Splash	Splash	Splash	Splash	Splash
Oil Quantity	24.7 oz.	24.7 oz.	24.7 oz.	24.7 oz.	24.7 oz.	24.7 oz.
Oil Type	30 W Non Detergent	30 W Non Detergent	30 W Non Detergent	30 W Non Detergent	30 W Non Detergent	30 W Non Detergent
Crankcase	Cast Iron	Cast Iron	Cast Iron	Cast Iron	Cast Iron	Cast Iron
Bearings	Ball	Ball	Ball	Ball	Ball	Ball
Cylinder	Cast Iron	Cast Iron	Cast Iron	Cast Iron	Cast Iron	Cast Iron
Valves	Reed	Reed	Reed	Reed	Reed	Reed
Head	Aluminum	Aluminum	Aluminum	Aluminum	Aluminum	Aluminum
Filter	Canister	Canister	Canister	Canister	Canister	Canister
Pilot Valve Setting:						
Cut-out	175 PSI	175 PSI	175 PSI	175 PSI	175 PSI	175 PSI
Cut-in	145 PSI	145 PSI	145 PSI	145 PSI	145 PSI	145 PSI
AIR TANK:						
Capacity	8 gallons	20 gallons	30 gallons	20 gallons	30 gallons	-
PERFORMANCE:						
CFM Air Displacement	20.3	20.3	20.3	20.3	20.3	20.3
CFM @ 40 PSI	19.7	19.7	19.1	19.7	19.1	19.1
CFM @ 100 PSI	18.3	18.3	17.7	18.3	17.7	17.7
CFM @ 175 PSI	17.5	17.5	16.9	17.5	16.9	16.9
Maximum Pressure	175 PSI	175 PSI	175 PSI	175 PSI	175 PSI	175 PSI
Pump-up Time: 0-175 PSI	44 seconds	1 minute and 46 seconds	2 minutes and 50 seconds	2 minute and 50 seconds	2 minutes and 50 seconds	-
Recovery Time: 145-175 PSI	9 seconds	13 seconds	20 seconds	20 seconds	20 seconds	-
WEIGHT:						
Net	288 lbs	337 lbs	374 lbs	331 lbs	368 lbs	267 lbs
Shipping	358 lbs	387 lbs	424 lbs	381 lbs	418 lbs	317 lbs
DIMENSIONS:						
Basic L x W x H	44" x 26" x 33"	46" x 26" x 41.5"	46" x 27.5" x 45"	37" x 18" x 40"	40" x 18.5" x 43.5"	35" x 21.25" x 25.5"
Shipping L x W x H	48.5" x 30.5" x 40"	47" x 32" x 48.5"	47" x 37" x 48.5"	47" x 32" x 48.5"	47" x 32" x 48.5"	47" x 37" x 47"

FLOW CHART

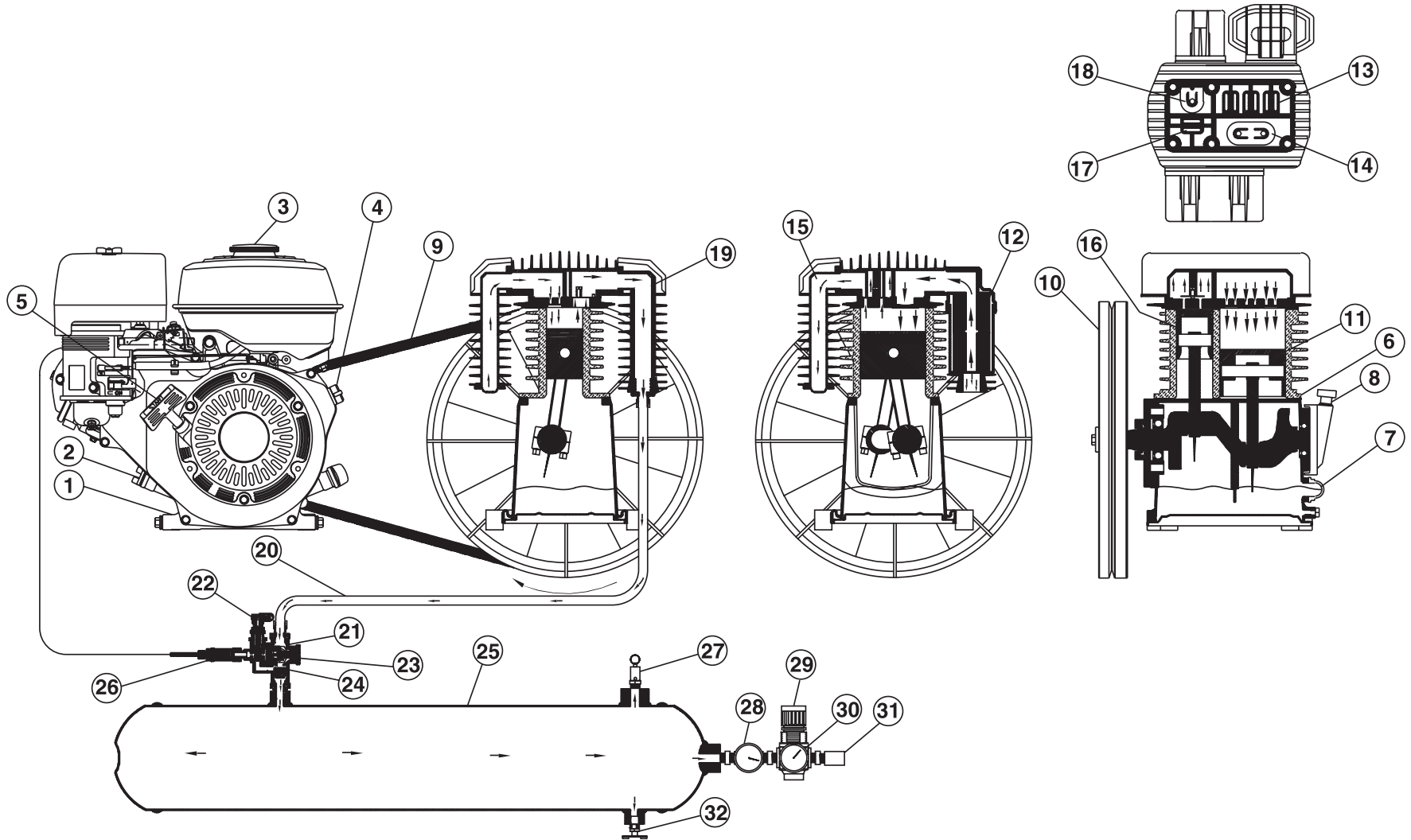

GENERAL THEORY OF OPERATION

1. The **ENGINE (1)** supplies power to the air compressor.
 - a. The **ENGINE (1)** is lubricated by oil. The oil level should be checked before each use by removing the **ENGINE OIL DIPSTICK (2)**.
 - b. The **ENGINE (1)** runs on gasoline. The **FUEL TANK (3)** level should be checked before each use.
 - c. The **ENGINE ON/OFF SWITCH (4)** and **STARTER ROPE (5)** are used to start the engine.
 - d. Refer to engine owner's manual for appropriate starting procedures and requirements of the **ENGINE (1)**.
2. The **COMPRESSOR PUMP (6)** is lubricated by oil. The oil level should be checked before each use by viewing the **COMPRESSOR PUMP OIL SIGHTGLASS (7)**. If the oil level is low, add SAE-30W non-detergent oil to the **COMPRESSOR PUMP OIL FILL PORT (8)**.
3. When the unit is operating, the **V-BELT (9)** turns the **COMPRESSOR PUMP FLYWHEEL (10)** which rotates the crankshaft and moves the pistons.
4. As the **FIRST STAGE PISTON (11)** moves down, air is drawn in through the **INLET AIR FILTER (12)**. Then through the **FIRST STAGE INLET REED VALVES (13)** and into the first stage piston chamber. At the same time, the **FIRST STAGE OUTLET REED VALVES (14)** is closed. This allows air to fill the first stage piston chamber.
5. As the **FIRST STAGE PISTON (11)** moves upward, the **FIRST STAGE INLET REED VALVE (13)** closes. The **FIRST STAGE OUTLET REED VALVE (14)** opens allowing the compressed air to flow into the **INTERCOOLER (15)** and into the second stage.
6. As the **SECOND STAGE PISTON (16)** moves down, the first stage compressed air is drawn in through the **SECOND STAGE INLET REED VALVES (17)** and into the second stage piston chamber. At the same time, the **SECOND STAGE OUTLET REED VALVES (18)** is closed.
7. As the **SECOND STAGE PISTON (16)** moves upward, the **SECOND STAGE INLET REED VALVES (17)** closes. The **SECOND STAGE OUTLET REED VALVES (18)** opens allowing the compressed air to flow into the **AFTERCOOLER (19)** and **DISCHARGE LINE (20)**.
8. The compressed air then enters the **PILOT CONTROL VALVE (21)** which has an **TOGGLE KNOB (22)** with two positions.
 - a. **Easy Start Position:** When the **TOGGLE KNOB (22)** is in the *open* position (*vertical*) air moves out the **PILOT VALVE MUFFLER (23)** allowing the **ENGINE (1)** to start under no-load conditions .
 - b. **Constant Run Position:** When the **TOGGLE KNOB (22)** is in the *closed* position (*horizontal*) the compressed air opens the **CHECK VALVE (24)** and moves into the **AIR TANK (25)**. When the pressure in the **AIR TANK (25)** reaches the maximum pressure setting of the **PILOT CONTROL VALVE (21)**, the excess air exits the **PILOT VALVE MUFFLER (23)** and the **CHECK VALVE (24)** will close. At the same time the **THROTTLE CONTROL (26)** allows the **ENGINE (1)** to idle down.
9. The **SAFETY RELIEF VALVE (27)** protects the system from any overpressure conditions.
10. The **TANK PRESSURE GAUGE (28)** indicates tank pressure. The **AIR PRESSURE REGULATOR (29)** can be adjusted to the desired operating pressure which is indicated on the **OUTLET PRESSURE GAUGE (30)**. The air exits through the **OUTLET FITTING (31)**.
11. The **ENGINE ON/OFF SWITCH (4)** stops the **ENGINE (1)** when moved to the "OFF" position.
12. When the **ENGINE (1)** is off, compressed air should be released from the **AIR TANK (25)** by opening the attached air tool or by pulling on the **SAFETY RELIEF VALVE (27)**. When the **TANK PRESSURE GAUGE (28)** registers less than 10 PSI, drain the condensation from the **AIR TANK (25)** by opening the **TANK DRAIN (32)**.

TANK ASSEMBLY FOR AM2-PH09-08M

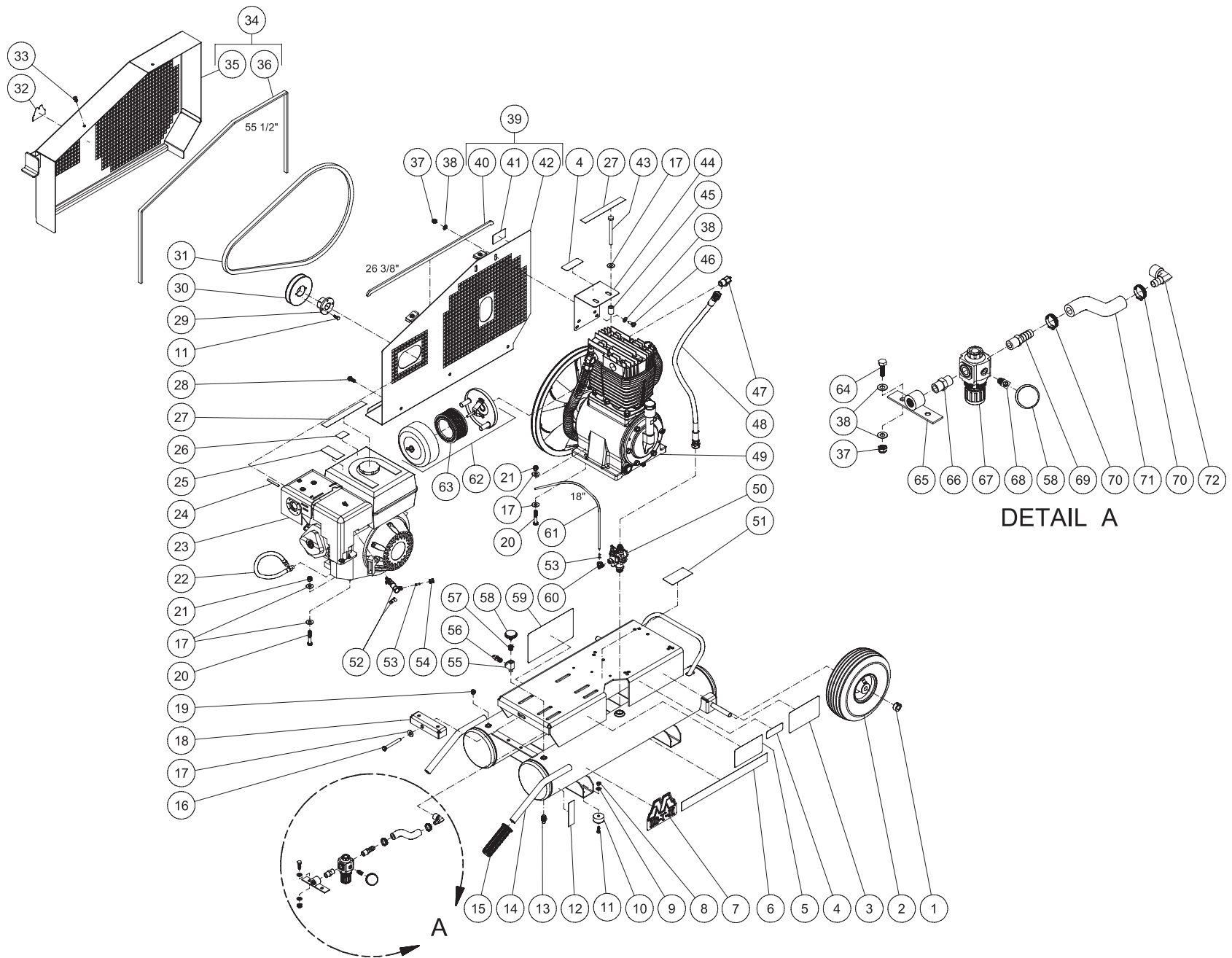

AM2-PH09-08M-030812-MLK

FRAME ASSEMBLY

ITEM	DESCRIPTION	PART #	QTY	ITEM	DESCRIPTION	PART #	QTY
1	COLLAR	33-0351	2	38	WASHER	28-0003	8
2	WHEEL	14-0017	2	39	BELTGUARD BACK ASSEMBLY (INC. 40-42)	854-0066	1
3	DECAL - MAINTENANCE INSTRUCTIONS (SEE 71-0086)	N/A	1	40	EDGING *(THREE FEET REQUIRED)	33-0020	1
4	DECAL - RISK OF BURNS (SEE 71-0086)	N/A	2	41	DECAL - BELTGUARD IN PLACE (SEE 71-0086)	N/A	1
5	DECAL - OPERATING INSTRUCTIONS (SEE 71-0086)	N/A	1	42	BELTGUARD BACK	6-0093A01	1
6	DECAL - STRIPE	34-2188	1	43	BOLT	27-8071	2
7	DECAL - Mi-T-M	34-2169	1	44	BRACKET	13-0189A01	1
8	LOCKNUT	30-0155	2	45	SPACER	33-0425	2
9	WASHER	28-0002	2	46	BOLT	27-0066	2
10	ISOLATOR	14-0069	2	47	ELBOW	24-0074	1
11	BOLT	27-0015	4	48	HOSE	15-0243	1
12	DECAL - TANK DRAIN (SEE 71-0086)	N/A	2	49	PUMP	3-0298	1
13	PETCOCK	23-0312	2	50	PILOT VALVE	22-0270	1
14	AIR TANK ASSEMBLY	12-0151A01	1	51	DECAL- SILVER STICKER	N/A	1
15	HANDLE GRIP	7-0059	2	52	THROTTLE CONTROL	854-0092	1
16	BOLT	27-0576	1	53	TUBE SUPPORT	23-0486	2
17	WASHER	28-0023	19	54	NUT	23-0315	1
18	TIGHTENER BRACKET	20-0650A01	1	55	TEE	23-0127	1
19	PLUG	23-0296	1	56	PRESSURE RELIEF VALVE	22-0267	1
20	BOLT	27-0121	8	57	REDUCER	23-0111	1
21	LOCKNUT	30-0159	8	58	PRESSURE GAUGE	22-0271	2
22	OIL DRAIN HOSE	70-0358	1	59	DECAL - CAUTION/WARNING/DANGER (SEE 71-0086)	N/A	1
23	ENGINE	1-0065	1	60	ELBOW	23-0316	1
24	KEY	43-0078	1	61	HOSE *(TWO FEET REQUIRED)	15-0238	1
25	DECAL - MUFFLER HOT (SEE 71-0086)	N/A	1	62	FILTER CANISTER	19-0237	1
26	DECAL - ENGINE FUEL (SEE 71-0086)	N/A	1	63	AIR FILTER	19-0226	1
27	DECAL - CHECK OIL (SEE 71-0086)	N/A	2	64	BOLT	27-0067	2
28	BOLT	27-9524	3	65	REGULATOR MOUNTING BRACKET	20-0421A01	1
29	BUSHING	9-0005	1	66	NIPPLE	24-0010	1
30	SHEAVE	10-0039	1	67	REGULATOR	22-0231	1
31	BELT	11-0066	1	68	ELBOW	23-0133	1
32	DECAL - Mi-T-M	34-2167	1	69	HOSE BARB	23-0105	1
33	FASTENER	33-0197	2	70	HOSE CLAMP	42-0011	2
34	BELTGUARD COVER ASSEMBLY (INC. 35-36)	854-0067	1	71	HOSE *(ONE FOOT REQUIRED)	15-0007	1
35	BELTGUARD FRONT	6-0094A01	1	72	HOSE BARB	23-0418	1
36	EDGING *(FIVE FEET REQUIRED)	33-0020	1	-	DECAL SET	71-0086	1
37	LOCKNUT	30-0157	4				

*MUST ORDER IN ONE FOOT LENGTHS

TANK ASSEMBLY FOR AM2-PH09-20M

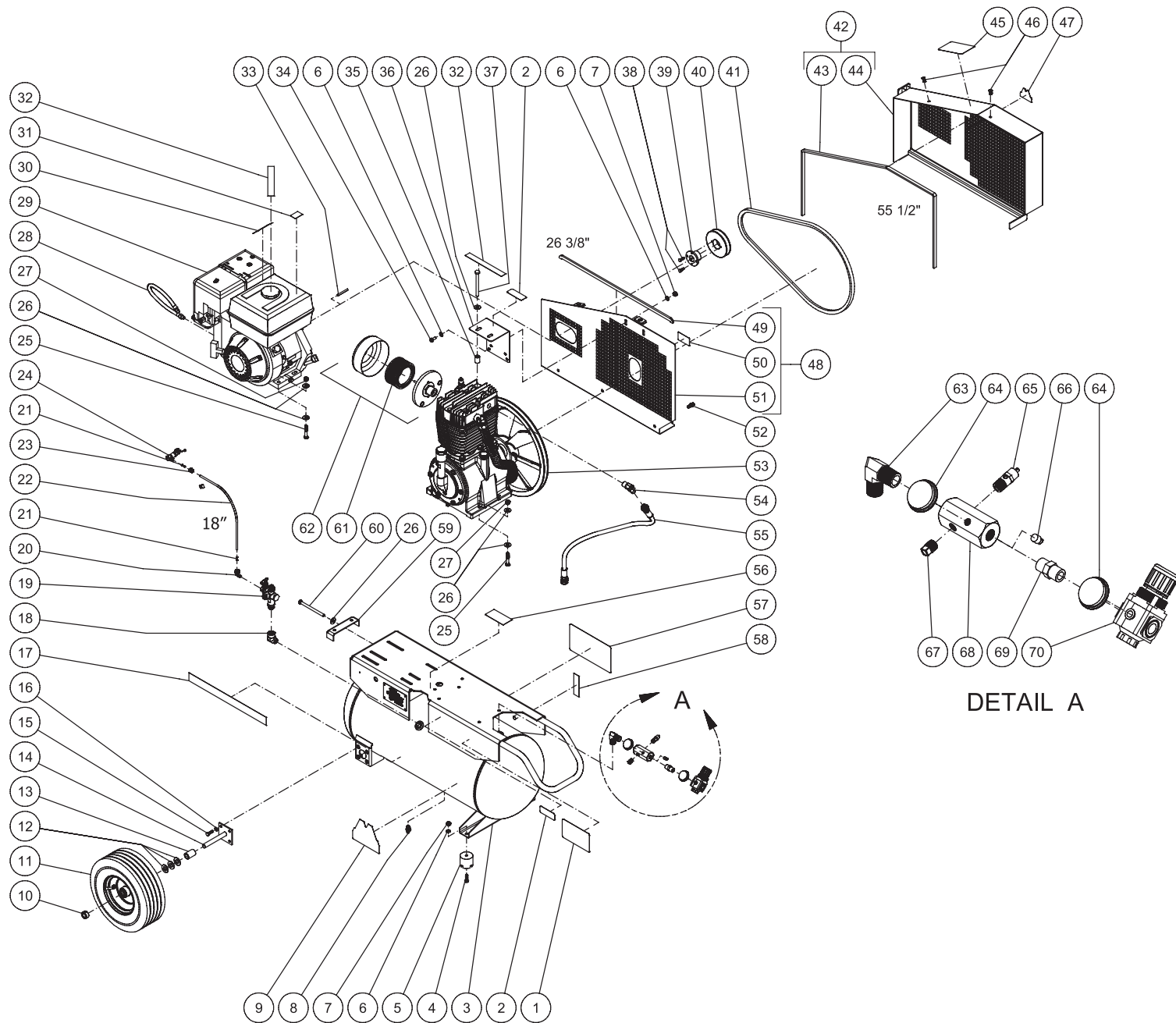

AM2-PH09-20M-030812-MLK

AM2-PH09-20M TANK ASSEMBLY

ITEM	DESCRIPTION	PART #	QTY	ITEM	DESCRIPTION	PART #	QTY
1	DECAL - MAINTENANCE INSTRUCTIONS (SEE 71-0086)	N/A	1	37	BOLT	27-8071	2
2	DECAL - RISK OF BURNS (SEE 71-0086)	N/A	2	38	BOLT	27-0015	2
3	TANK	12-0191A01	1	39	BUSHING	9-0005	1
4	BOLT	27-0068	2	40	SHEAVE	10-0039	1
5	ISOLATOR	14-0008	2	41	BELT	11-0062	1
6	WASHER	28-0003	6	42	BELTGUARD COVER ASSEMBLY	854-0067	1
7	LOCKNUT	30-0157	4	43	EDGING (FIVE FEET REQUIRED)	33-0020	1
8	PETCOCK	23-0312	1	44	BELTGUARD FRONT	6-0094A01	1
9	DECAL - Mi-T-M	34-2169	1	45	DECAL - OPERATING INSTRUCTIONS (SEE 71-0086)	N/A	1
10	COLLAR	33-0351	2	46	FASTENER	33-0197	2
11	WHEEL	14-0006	2	47	DECAL - Mi-T-M	34-2167	1
12	WASHER	28-0008	6	48	BELTGUARD BACK ASSEMBLY	854-0066	1
13	SPACER	62-0176	2	49	EDGING (THREE FEET REQUIRED)	33-0020	1
14	AXLE	20-0670A01	2	50	DECAL - BELTGUARD IN PLACE (SEE 71-0086)	N/A	1
15	BOLT	27-0067	8	51	BELTGUARD BACK	6-0093A01	1
16	LOCKWASHER	29-0007	8	52	BOLT	27-9524	3
17	DECAL - STRIPE	34-2188	1	53	PUMP	3-0298	1
18	ELBOW	24-0041	1	54	ELBOW	24-0074	1
19	PILOT VALVE	22-0270	1	55	HOSE	15-0243	1
20	ELBOW	23-0316	1	56	DECAL- SILVER STICKER	N/A	1
21	TUBE SUPPORT	23-0486	2	57	DECAL - CAUTION/WARNING/DANGER (SEE 71-0086)	N/A	1
22	HOSE *(TWO FEET REQUIRED)	15-0238	1	58	DECAL - TANK DRAIN (SEE 71-0086)	N/A	1
23	NUT	23-0315	1	59	TIGHTENER BRACKET	20-0650A01	1
24	THROTTLE CONTROL	33-0413	1	60	BOLT	27-0133	1
25	BOLT	27-0121	8	61	AIR FILTER	19-0226	1
26	WASHER	28-0023	19	62	FILTER CANISTER	19-0237	1
27	LOCKNUT	30-0159	8	63	ELBOW	24-0267	1
28	OIL DRAIN HOSE	70-0358	1	64	PRESSURE GAUGE	22-0271	2
29	ENGINE	1-0065	1	65	PRESSURE RELIEF VALVE	22-0267	1
30	DECAL - MUFFLER HOT (SEE 71-0086)	N/A	1	66	PLUG	24-0082	1
31	DECAL - ENGINE FUEL (SEE 71-0086)	N/A	1	67	PLUG	24-0009	1
32	DECAL - CHECK OIL (SEE 71-0086)	N/A	2	68	MANIFOLD	24-0266	1
33	KEY	43-0078	1	69	NIPPLE	24-0010	1
34	BOLT	27-0066	2	70	REGULATOR	22-0231	1
35	SPACER	33-0425	2	-	DECAL SET	71-0086	1
36	BRACKET	13-0189A01	1				

TANK ASSEMBLY FOR AM2-PH09-30M

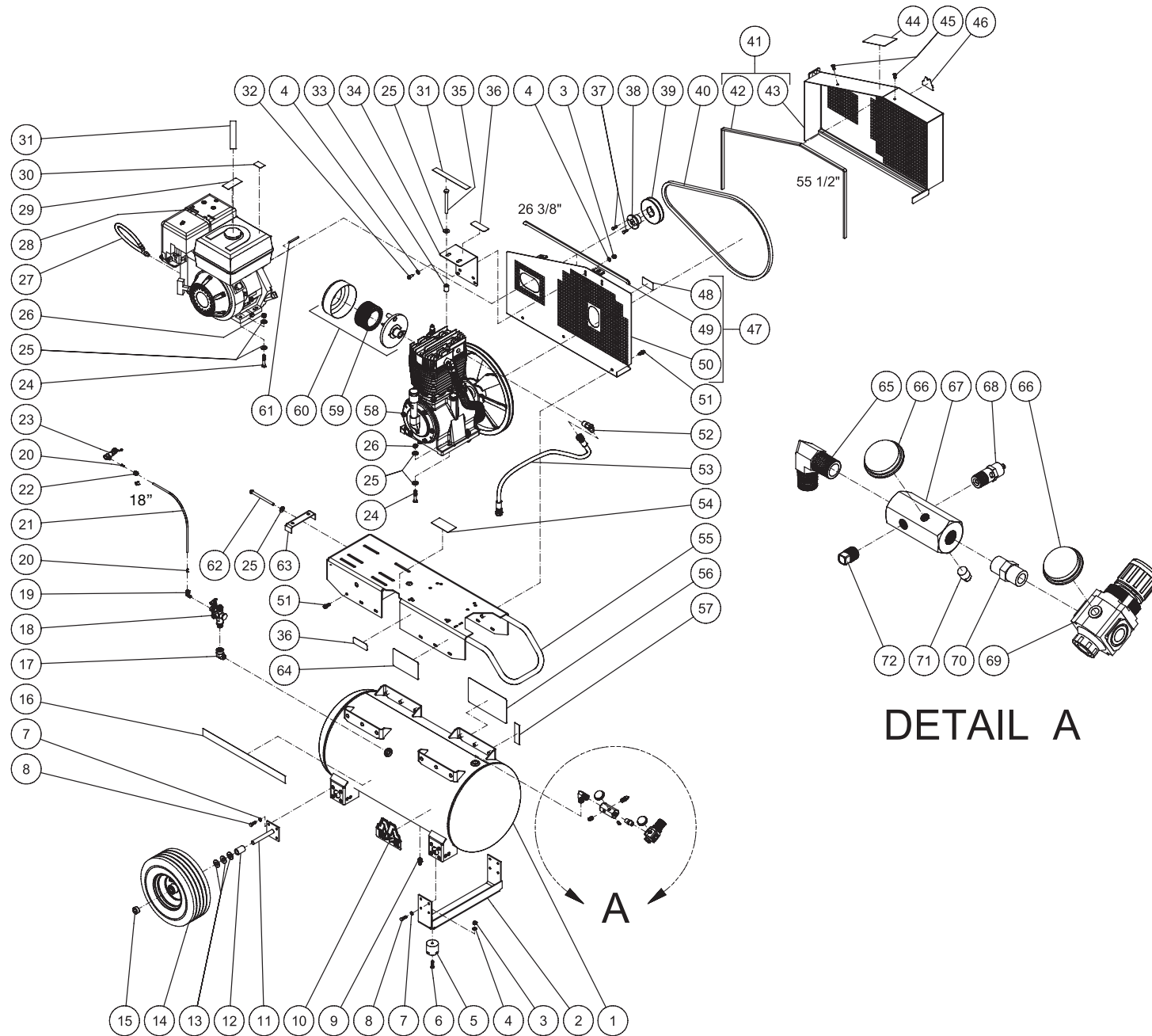

AM2-PH09-30M-030812-MLK

AM2-PH09-30M TANK ASSEMBLY

ITEM	DESCRIPTION	PART #	QTY	ITEM	DESCRIPTION	PART #	QTY
1	TANK	12-0193A01	1	38	BUSHING	9-0005	1
2	SUPPORT FOOT BRACKET	20-0671A01	1	39	SHEAVE	10-0039	1
3	LOCKNUT	30-0157	4	40	BELT	11-0066	1
4	WASHER	28-0003	6	41	BELTGUARD COVER ASSEMBLY	854-0067	1
5	ISOLATOR	14-0008	2	42	EDGING *(FIVE FEET REQUIRED)	33-0020	1
6	BOLT	27-0068	2	43	BELTGUARD FRONT	N/A	1
7	LOCKWASHER	29-0007	16	44	DECAL - OPERATING INSTRUCTIONS (SEE 71-0086)	N/A	1
8	BOLT	27-0067	16	45	FASTENER	33-0197	2
9	PETCOCK	23-0312	1	46	DECAL - Mi-T-M	34-2167	1
10	DECAL - Mi-T-M	34-2169	1	47	BELTGUARD BACK ASSEMBLY	854-0066	1
11	AXLE	20-0670A01	2	48	DECAL - BELTGUARD IN PLACE (SEE 71-0086)	N/A	1
12	SPACER	62-0176	2	49	EDGING *(THREE FEET REQUIRED)	33-0020	1
13	WASHER	28-0008	6	50	BELTGUARD BACK	N/A	1
14	WHEEL	14-0006	2	51	BOLT	27-9524	15
15	COLLAR	33-0351	2	52	ELBOW	24-0074	1
16	DECAL - Mi-T-M STRIPE	34-2189	1	53	HOSE	15-0243	1
17	ELBOW	24-0041	1	54	DECAL- SILVER STICKER	N/A	1
18	PILOT VALVE	22-0270	1	55	BASEPLATE	5-0198A01	1
19	ELBOW	23-0316	1	56	DECAL - CAUTION/WARNING/DANGER (SEE 71-0086)	N/A	1
20	TUBE SUPPORT	23-0486	2	57	DECAL - TANK DRAIN (SEE 71-0086)	N/A	1
21	HOSE *(TWO FEET REQUIRED)	15-0238	1	58	PUMP	3-0298	1
22	NUT	23-0315	1	59	AIR FILTER	19-0226	1
23	THROTTLE CONTROL	33-0413	1	60	FILTER CANISTER	19-0237	1
24	BOLT	27-0121	8	61	KEY	43-0078	1
25	WASHER	28-0023	19	62	BOLT	27-0133	1
26	LOCKNUT	30-0159	8	63	TIGHTENER BRACKET	20-0650A01	1
27	OIL DRAIN HOSE	70-0358	1	64	DECAL - MAINTENANCE INSTRUCTIONS (SEE 71-0086)	N/A	1
28	ENGINE	1-0065	1	65	ELBOW	24-0267	1
29	DECAL - MUFFLER HOT (SEE 71-0086)	N/A	1	66	PRESSURE GAUGE	22-0271	2
30	DECAL - ENGINE FUEL (SEE 71-0086)	N/A	1	67	MANIFOLD	24-0266	1
31	DECAL - CHECK OIL (SEE 71-0086)	N/A	2	68	PRESSURE RELIEF VALVE	22-0267	1
32	BOLT	27-0066	2	69	REGULATOR	22-0231	1
33	SPACER	33-0425	2	70	NIPPLE	24-0010	1
34	BRACKET	13-0189A01	1	71	PLUG	24-0082	1
35	BOLT	27-8071	2	72	PLUG	24-0009	1
36	DECAL - RISK OF BURNS (SEE 71-0086)	N/A	2	-	DECAL SET	71-0086	1
37	BOLT	27-0015	2	*MUST ORDER IN ONE FOOT LENGTHS			

TANK ASSEMBLY FOR AM2-PK95_PR09-08M

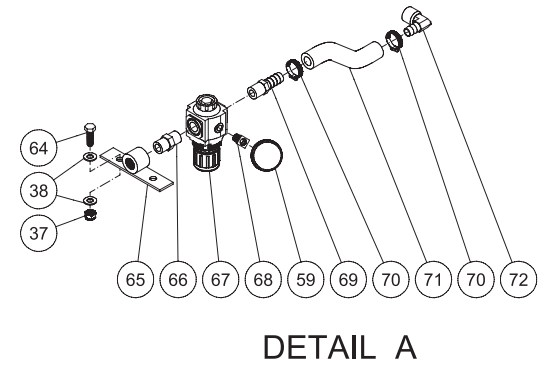
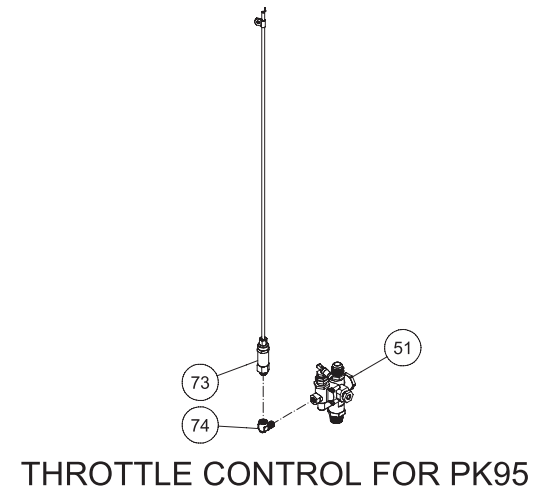
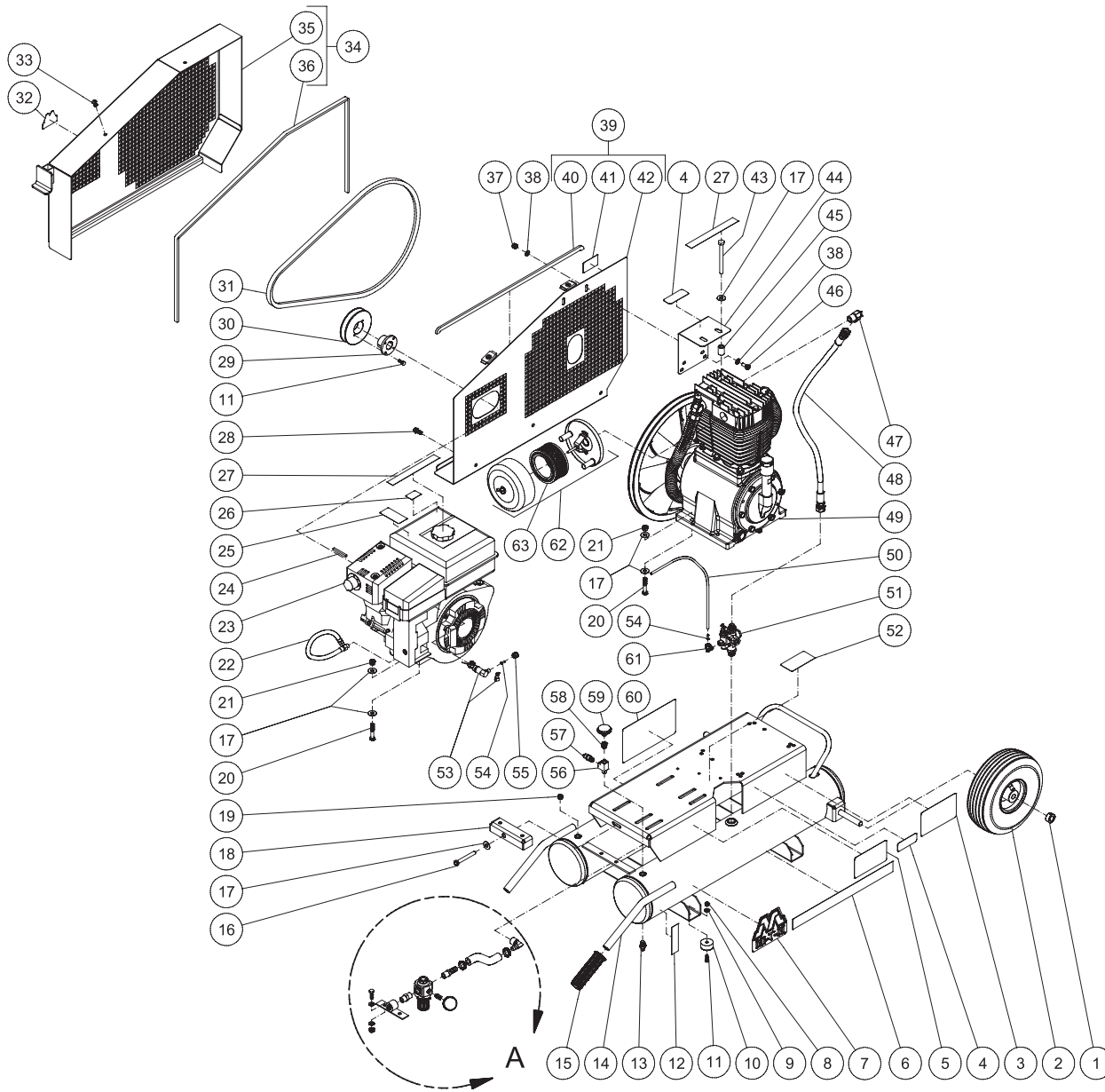

AM2-PK95_PR09-08M-020912-MLK

FRAME ASSEMBLY

ITEM	DESCRIPTION	PART #	QTY	ITEM	DESCRIPTION	PART #	QTY
1	COLLAR	33-0351	2	38	WASHER	28-0003	8
2	WHEEL	14-0017	2	39	BELTGUARD BACK ASSEMBLY (INC. 40-42)	854-0066	1
3	DECAL - MAINTENANCE INSTRUCTIONS (SEE 71-0078)	N/A	1	40	EDGING *(THREE FEET REQUIRED)	33-0020	1
4	DECAL - RISK OF BURNS (SEE 71-0078)	N/A	2	41	DECAL - BELTGUARD IN PLACE (SEE 71-0078)	N/A	1
5	DECAL - OPERATING INSTRUCTIONS (SEE 71-0078)	N/A	1	42	BELTGUARD BACK	6-0093A01	1
6	DECAL - STRIPE	34-2188	1	43	BOLT	27-8071	2
7	DECAL - Mi-T-M	34-2169	1	44	BRACKET	13-0189A01	1
8	LOCKNUT	30-0155	2	45	SPACER	33-0425	2
9	WASHER	28-0002	2	46	BOLT	27-0066	2
10	ISOLATOR	14-0069	2	47	ELBOW	24-0074	1
11	BOLT	27-0015	4	48	HOSE	15-0243	1
12	DECAL - TANK DRAIN (SEE 71-0078)	N/A	2	49	PUMP	3-0298	1
13	PETCOCK	23-0312	2	50	HOSE *(TWO FEET REQUIRED) (AM2-PR09)	15-0238	1
14	AIR TANK ASSEMBLY	12-0151A01	1	51	PILOT VALVE	22-0270	1
15	HANDLE GRIP	7-0059	2	52	DECAL - SILVER STICKER	N/A	1
16	BOLT	27-0576	1	53	AIR THROTTLE CONTROL (AM2-PR09)	854-0091	1
17	WASHER	28-0023	19	54	TUBE SUPPORT (AM2-PR09)	23-0486	2
18	TIGHTENER BRACKET	20-0650A01	1	55	NUT (AM2-PR09)	23-0315	1
19	PLUG	23-0296	1	56	TEE	23-0127	1
20	BOLT	27-0121	8	57	PRESSURE RELIEF VALVE	22-0267	1
21	LOCKNUT	30-0159	8	58	REDUCER	23-0111	1
22	HOSE	70-0380	1	59	PRESSURE GAUGE	22-0271	2
23	ENGINE - SUBARU (AM2-PR09)	1-0134	1	60	DECAL - CAUTION/WARNING/DANGER (SEE 71-0078)	N/A	1
-	ENGINE - KOHLER (AM2-PK95)	1-0207	1	61	ELBOW (AM2-PR09)	23-0316	1
24	KEY	43-0078	1	62	FILTER CANISTER	19-0237	1
25	DECAL - MUFFLER HOT (SEE 71-0078)	N/A	1	63	AIR FILTER	19-0226	1
26	DECAL - ENGINE FUEL (SEE 71-0078)	N/A	1	64	BOLT	27-0067	2
27	DECAL - CHECK OIL (SEE 71-0078)	N/A	2	65	REGULATOR MOUNTING BRACKET	20-0421A01	1
28	BOLT	27-9524	3	66	NIPPLE	24-0010	1
29	BUSHING	9-0005	1	67	REGULATOR	22-0231	1
30	SHEAVE	10-0039	1	68	ELBOW	23-0133	1
31	BELT	11-0066	1	69	HOSE BARB	23-0105	1
32	DECAL - Mi-T-M	34-2167	1	70	HOSE CLAMP	42-0011	2
33	FASTENER	33-0197	2	71	HOSE	15-0007	1
34	BELTGUARD COVER ASSEMBLY (INC. 35-36)	854-0067	1	72	HOSE BARB	23-0418	1
35	BELTGUARD FRONT	6-0094A01	1	73	AIR THROTTLE (AM2-PK95)	33-0294	1
36	EDGING *(FIVE FEET REQUIRED)	33-0020	1	74	ELBOW (AM2-PK95)	23-0118	1
37	LOCKNUT	30-0157	4	-	DECAL SET	71-0078	1

TANK ASSEMBLY FOR AM2-PR09-20M

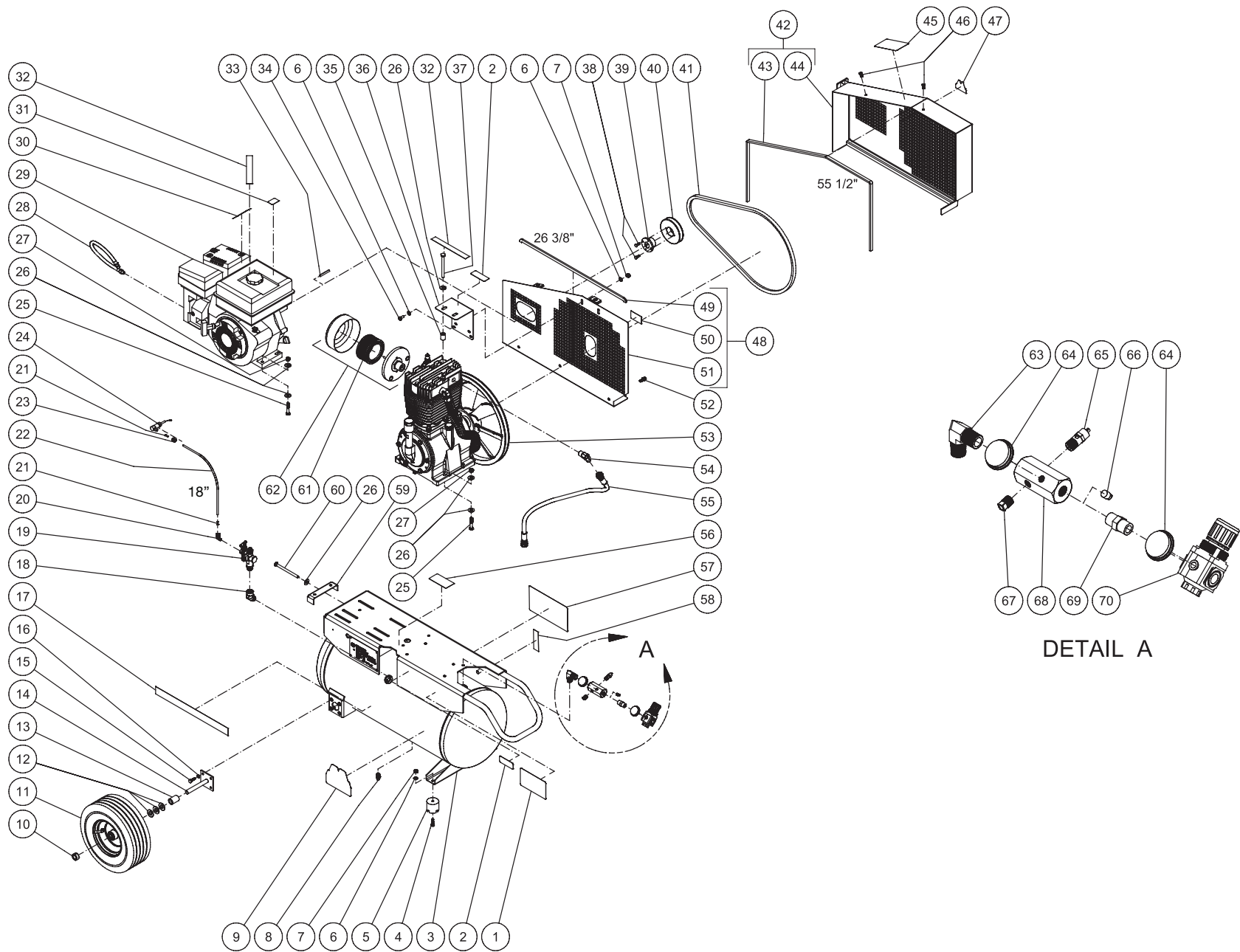

AM2-PR09-20M-030812-MLK

AM2-PR09-20M TANK ASSEMBLY							
ITEM	DESCRIPTION	PART #	QTY	ITEM	DESCRIPTION	PART #	QTY
1	DECAL - MAINTENANCE INSTRUCTIONS (SEE 71-0086)	N/A	1	37	BOLT	27-8071	2
2	DECAL - RISK OF BURNS (SEE 71-0086)	N/A	2	38	BOLT	27-0015	2
3	TANK	12-0191A01	1	39	BUSHING	9-0005	1
4	BOLT	27-0068	2	40	SHEAVE	10-0039	1
5	ISOLATOR	14-0008	2	41	BELT	11-0062	1
6	WASHER	28-0003	6	42	BELTGUARD COVER ASSEMBLY	854-0067	1
7	LOCKNUT	30-0157	4	43	EDGING (FIVE FEET REQUIRED)	33-0020	1
8	PETCOCK	23-0312	1	44	BELTGUARD FRONT	6-0094A01	1
9	DECAL - Mi-T-M	34-2169	1	45	DECAL - OPERATING INSTRUCTIONS (SEE 71-0086)	N/A	1
10	COLLAR	33-0351	2	46	FASTENER	33-0197	2
11	WHEEL	14-0006	2	47	DECAL - Mi-T-M	34-2167	1
12	WASHER	28-0008	6	48	BELTGUARD BACK ASSEMBLY	854-0066	1
13	SPACER	62-0176	2	49	EDGING (THREE FEET REQUIRED)	33-0020	1
14	AXLE	20-0670A01	2	50	DECAL - BELTGUARD IN PLACE (SEE 71-0086)	N/A	1
15	BOLT	27-0067	8	51	BELTGUARD BACK	6-0093A01	1
16	LOCKWASHER	29-0007	8	52	BOLT	27-9524	3
17	DECAL - STRIPE	34-2188	1	53	PUMP	3-0298	1
18	ELBOW	24-0041	1	54	ELBOW	24-0074	1
19	PILOT VALVE	22-0270	1	55	HOSE	15-0243	1
20	ELBOW	23-0316	1	56	DECAL- SILVER STICKER	N/A	1
21	TUBE SUPPORT	23-0486	2	57	DECAL - CAUTION/WARNING/DANGER (SEE 71-0086)	N/A	1
22	HOSE *(TWO FEET REQUIRED)	15-0238	1	58	DECAL - TANK DRAIN (SEE 71-0086)	N/A	1
23	NUT	23-0315	1	59	TIGHTENER BRACKET	20-0650A01	1
24	AIR THROTTLE CONTROL	33-0394	1	60	BOLT	27-0133	1
25	BOLT	27-0121	8	61	AIR FILTER	19-0226	1
26	WASHER	28-0023	19	62	FILTER CANISTER	19-0237	1
27	LOCKNUT	30-0159	8	63	ELBOW	24-0267	1
28	OIL DRAIN HOSE	70-0358	1	64	PRESSURE GAUGE	22-0271	2
29	ENGINE	1-0134	1	65	PRESSURE RELIEF VALVE	22-0267	1
30	DECAL - MUFFLER HOT (SEE 71-0086)	N/A	1	66	PLUG	24-0082	1
31	DECAL - ENGINE FUEL (SEE 71-0086)	N/A	1	67	PLUG	24-0009	1
32	DECAL - CHECK OIL (SEE 71-0086)	N/A	2	68	MANIFOLD	24-0266	1
33	KEY	43-0078	1	69	NIPPLE	24-0010	1
34	BOLT	27-0066	2	70	REGULATOR	22-0231	1
35	SPACER	33-0425	2	-	DECAL SET	71-0086	1
36	BRACKET	13-0189A01	1				

TANK ASSEMBLY FOR AM2-PR09-30M

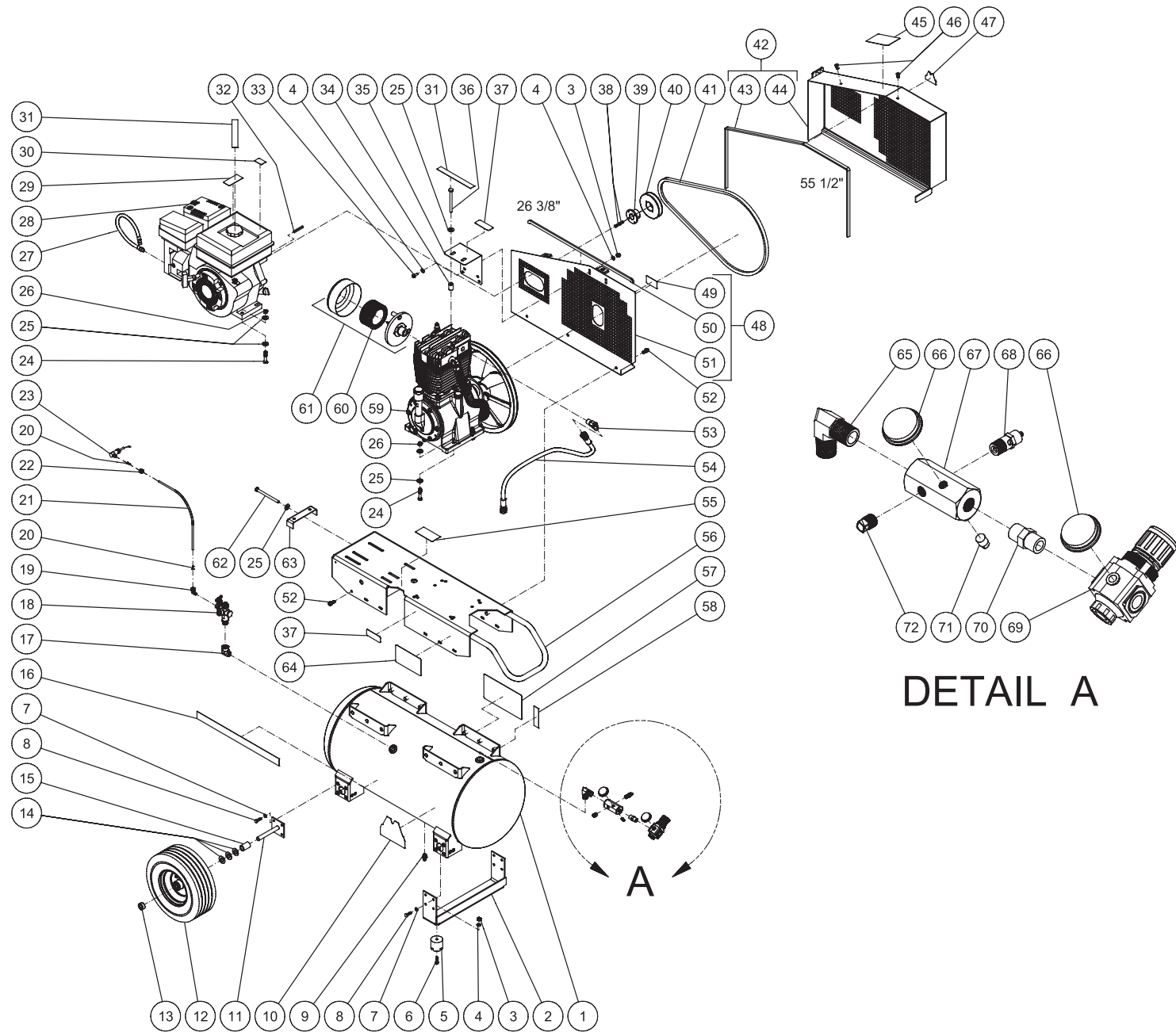

AM2-PR09-30M-030912-MLK

AM2-PR09-30M TANK ASSEMBLY							
ITEM	DESCRIPTION	PART #	QTY	ITEM	DESCRIPTION	PART #	QTY
1	TANK	12-0193A01	1	38	BOLT	27-0015	2
2	SUPPORT FOOT BRACKET	20-0671A01	1	39	BUSHING	9-0005	1
3	LOCKNUT	30-0157	4	40	SHEAVE	10-0039	1
4	WASHER	28-0003	6	41	BELT	11-0066	1
5	ISOLATOR	14-0008	2	42	BELTGUARD COVER ASSEMBLY	854-0067	1
6	BOLT	27-0068	2	43	EDGING (FIVE FEET REQUIRED)	33-0020	1
7	LOCKWASHER	29-0007	16	44	BELTGUARD FRONT	6-0094A01	1
8	BOLT	27-0067	16	45	DECAL - OPERATING INSTRUCTIONS (SEE 71-0086)	N/A	1
9	PETCOCK	23-0312	1	46	FASTENER	33-0197	2
10	DECAL - Mi-T-M	34-2169	1	47	DECAL - Mi-T-M	34-2167	1
11	AXLE	20-0670A01	2	48	BELTGUARD BACK ASSEMBLY	854-0066	1
12	WHEEL	14-0006	2	49	DECAL - BELTGUARD IN PLACE (SEE 71-0086)	N/A	1
13	COLLAR	33-0351	2	50	EDGING (THREE FEET REQUIRED)	33-0020	1
14	WASHER	28-0008	6	51	BELTGUARD BACK	6-0093A01	1
15	SPACER	62-0176	2	52	BOLT	27-9524	15
16	DECAL - STRIPE	34-2189	1	53	ELBOW	24-0074	1
17	ELBOW	24-0041	1	54	HOSE	15-0243	1
18	PILOT VALVE	22-0270	1	55	DECAL- SILVER STICKER	N/A	1
19	ELBOW	23-0316	1	56	BASEPLATE	5-0198A01	1
20	TUBE SUPPORT	23-0486	2	57	DECAL - CAUTION/WARNING/DANGER (SEE 71-0086)	N/A	1
21	HOSE *(TWO FEET REQUIRED)	15-0238	1	58	DECAL - TANK DRAIN (SEE 71-0086)	N/A	1
22	NUT	23-0315	1	59	PUMP	3-0298	1
23	AIR THROTTLE CONTROL	33-0394	1	60	AIR FILTER	19-0226	1
24	BOLT	27-0121	8	61	FILTER CANISTER	19-0237	1
25	WASHER	28-0023	19	62	BOLT	27-0133	1
26	LOCKNUT	30-0159	8	63	TIGHTENER BRACKET	20-0650A01	1
27	HOSE	70-0380	1	64	DECAL - MAINTENANCE INSTRUCTIONS (SEE 71-0086)	N/A	1
28	ENGINE	1-0134	1	65	ELBOW	24-0267	1
29	DECAL - MUFFLER HOT (SEE 71-0086)	N/A	1	66	PRESSURE GAUGE	22-0271	2
30	DECAL - ENGINE FUEL (SEE 71-0086)	N/A	1	67	MANIFOLD	24-0266	1
31	DECAL - CHECK OIL (SEE 71-0086)	N/A	2	68	PRESSURE RELIEF VALVE	22-0267	1
32	KEY	43-0078	1	69	REGULATOR	22-0231	1
33	BOLT	27-0066	2	70	NIPPLE	24-0010	1
34	SPACER	33-0425	2	71	PLUG	24-0082	1
35	BRACKET	13-0189A01	1	72	PLUG	24-0009	1
36	BOLT	27-8071	2	-	DECAL SET	71-0086	1
37	DECAL - RISK OF BURNS (SEE 71-0086)	N/A	2				

TANK ASSEMBLY FOR AM2-SH09-20M

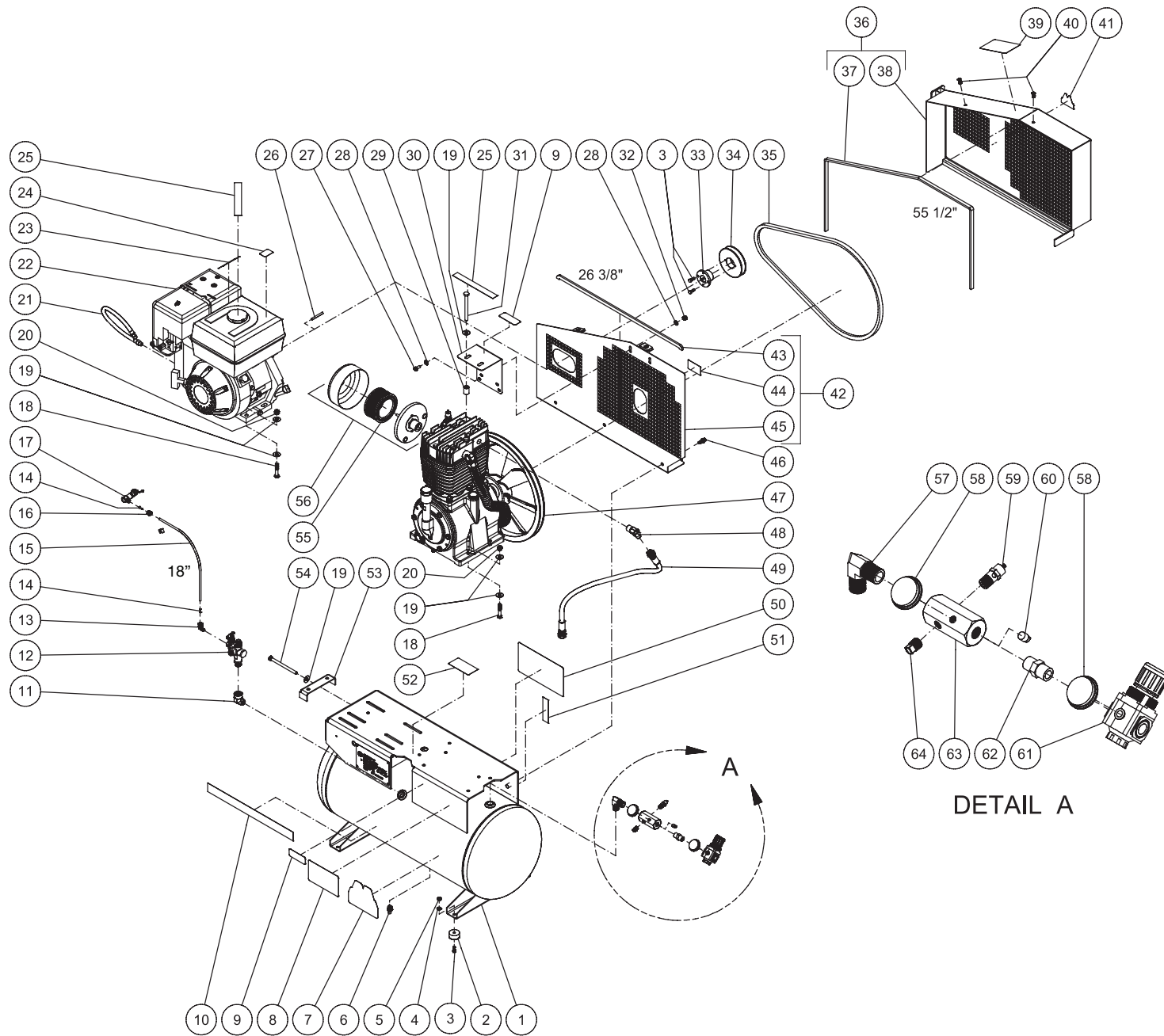

AM2-SH098-20M-030912-MLK

AM2-SH09-20M TANK ASSEMBLY							
ITEM	DESCRIPTION	PART #	QTY	ITEM	DESCRIPTION	PART #	QTY
1	TANK	12-0192A01	1	34	SHEAVE	10-0039	1
2	ISOLATOR	14-0069	4	35	BELT	11-0062	1
3	BOLT	27-0015	6	36	BELTGUARD COVER ASSEMBLY	854-0067	1
4	WASHER	28-0002	4	37	EDGING (FIVE FEET REQUIRED)	33-0020	1
5	LOCKNUT	30-0155	4	38	BELTGUARD FRONT	6-0094A01	1
6	PETCOCK	23-0312	1	39	DECAL - OPERATING INSTRUCTIONS (SEE 71-0086)	N/A	1
7	DECAL - Mi-T-M	34-2169	1	40	FASTENER	33-0197	2
8	DECAL - MAINTENANCE INSTRUCTIONS (SEE 71-0086)	N/A	1	41	DECAL - Mi-T-M	34-2167	1
9	DECAL - RISK OF BURNS (SEE 71-0086)	N/A	2	42	BELTGUARD BACK ASSEMBLY	854-0066	1
10	DECAL - STRIPE	34-2188	1	43	EDGING (THREE FEET REQUIRED)	33-0020	1
11	ELBOW	24-0041	1	44	DECAL - BELTGUARD IN PLACE (SEE 71-0086)	N/A	1
12	PILOT VALVE	22-0270	1	45	BELTGUARD BACK	6-0093A01	1
13	ELBOW	23-0316	1	46	BOLT	27-9524	3
14	TUBE SUPPORT	23-0486	2	47	PUMP	3-0298	1
15	HOSE *(TWO FEET REQUIRED)	15-0238	1	48	ELBOW	24-0074	1
16	NUT	23-0315	1	49	HOSE	15-0243	1
17	THROTTLE CONTROL	33-0413	1	50	DECAL - CAUTION/WARNING/DANGER (SEE 71-0086)	N/A	1
18	BOLT	27-0121	8	51	DECAL - TANK DRAIN (SEE 71-0086)	N/A	1
19	WASHER	28-0023	19	52	DECAL- SILVER STICKER	N/A	1
20	LOCKNUT	30-0159	8	53	TIGHTENER BRACKET	20-0650A01	1
21	OIL DRAIN HOSE	70-0358	1	54	BOLT	27-0133	1
22	ENGINE	1-0065	1	55	AIR FILTER	19-0226	1
23	DECAL - MUFFLER HOT (SEE 71-0086)	N/A	1	56	FILTER CANISTER	19-0237	1
24	DECAL - ENGINE FUEL (SEE 71-0086)	N/A	1	57	ELBOW	24-0267	1
25	DECAL - CHECK OIL (SEE 71-0086)	3N/A	2	58	PRESSURE GAUGE	22-0271	2
26	KEY	43-0078	1	59	PRESSURE RELIEF VALVE	22-0267	1
27	BOLT	27-0066	2	60	PLUG	24-0082	1
28	WASHER	28-0003	4	61	REGULATOR	22-0231	1
29	SPACER	33-0425	2	62	NIPPLE	24-0010	1
30	BRACKET	13-0189A01	1	63	MANIFOLD	24-0266	1
31	BOLT	27-8071	2	64	PLUG	24-0009	1
32	LOCKNUT	30-0157	2	-	DECAL SET	71-0086	1
33	BUSHING	9-0005	1				

TANK ASSEMBLY FOR AM2-SH09-30M

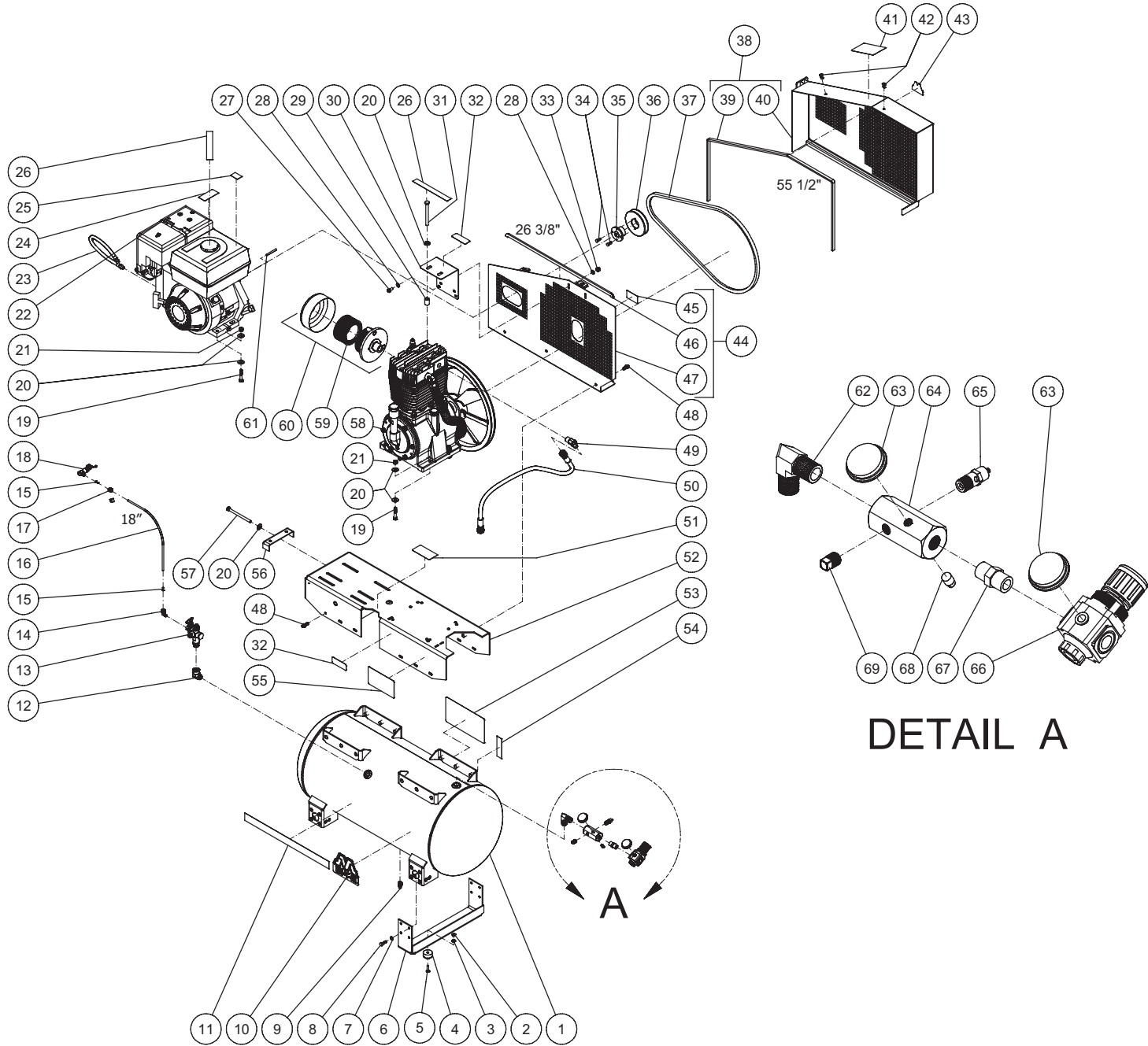

DETAIL A

AM2-SH09-30M-030912-MLK

AM2-SH09-30M TANK ASSEMBLY

ITEM	DESCRIPTION	PART #	QTY	ITEM	DESCRIPTION	PART #	QTY
1	TANK	12-0193A01	1	36	SHEAVE	10-0039	1
2	LOCKNUT	30-0155	4	37	BELT	11-0066	1
3	WASHER	28-0002	4	38	BELTGUARD COVER ASSEMBLY	854-0067	1
4	ISOLATOR	14-0069	4	39	EDGING (FIVE FEET REQUIRED)	33-0020	1
5	BOLT	27-0016	4	40	BELTGUARD FRONT	6-0094A01	1
6	SUPPORT FOOT BRACKET	20-0671A01	2	41	DECAL - OPERATING INSTRUCTIONS (SEE 71-0086)	N/A	1
7	LOCKWASHER	29-0007	16	42	FASTENER	33-0197	2
8	BOLT	27-0067	16	43	DECAL - Mi-T-M	34-2167	1
9	PETCOCK	23-0312	1	44	BELTGUARD BACK ASSEMBLY	854-0066	1
10	DECAL - Mi-T-M	34-2169	1	45	DECAL - BELTGUARD IN PLACE (SEE 71-0086)	N/A	1
11	DECAL - STRIPE	34-2189	1	46	EDGING (THREE FEET REQUIRED)	33-0020	1
12	ELBOW	24-0041	1	47	BELTGUARD BACK	6-0093A01	1
13	PILOT VALVE	22-0270	1	48	BOLT	27-9524	15
14	ELBOW	23-0316	1	49	ELBOW	24-0074	1
15	TUBE SUPPORT	23-0486	2	50	HOSE	15-0243	1
16	HOSE *(TWO FEET REQUIRED)	15-0238	1	51	DECAL- SILVER STICKER	N/A	1
17	NUT	23-0315	1	52	BASEPLATE	5-0197A01	1
18	THROTTLE CONTROL	33-0413	1	53	DECAL - CAUTION/WARNING/DANGER (SEE 71-0086)	N/A	1
19	BOLT	27-0121	8	54	DECAL - TANK DRAIN (SEE 71-0086)	N/A	1
20	WASHER	28-0023	19	55	DECAL - MAINTENANCE INSTRUCTIONS (SEE 71-0086)	N/A	1
21	LOCKNUT	30-0159	8	56	TIGHTENER BRACKET	20-0650A01	1
22	ENGINE	1-0065	1	57	BOLT	27-0133	1
23	OIL DRAIN HOSE	70-0358	1	58	PUMP	3-0298	1
24	DECAL - MUFFLER HOT (SEE 71-0086)	N/A	1	59	AIR FILTER	19-0226	1
25	DECAL - ENGINE FUEL (SEE 71-0086)	N/A	1	60	FILTER CANISTER	19-0237	1
26	DECAL - CHECK OIL (SEE 71-0086)	N/A	2	61	KEY	43-0078	1
27	BOLT	27-0066	2	62	ELBOW	24-0267	1
28	WASHER	28-0003	4	63	PRESSURE GAUGE	22-0271	2
29	SPACER	33-0425	2	64	MANIFOLD	24-0266	1
30	BRACKET	13-0189A01	1	65	PRESSURE RELIEF VALVE	22-0267	1
31	BOLT	27-8071	2	66	REGULATOR	22-0231	1
32	DECAL - RISK OF BURNS (SEE 71-0086)	N/A	2	67	NIPPLE	24-0010	1
33	LOCKNUT	30-0157	2	68	PLUG	24-0082	1
34	BOLT	27-0015	2	69	PLUG	24-0009	1
35	BUSHING	9-0005	1	-	DECAL SET	71-0086	1

TANK ASSEMBLY FOR AM2-SR09-20M

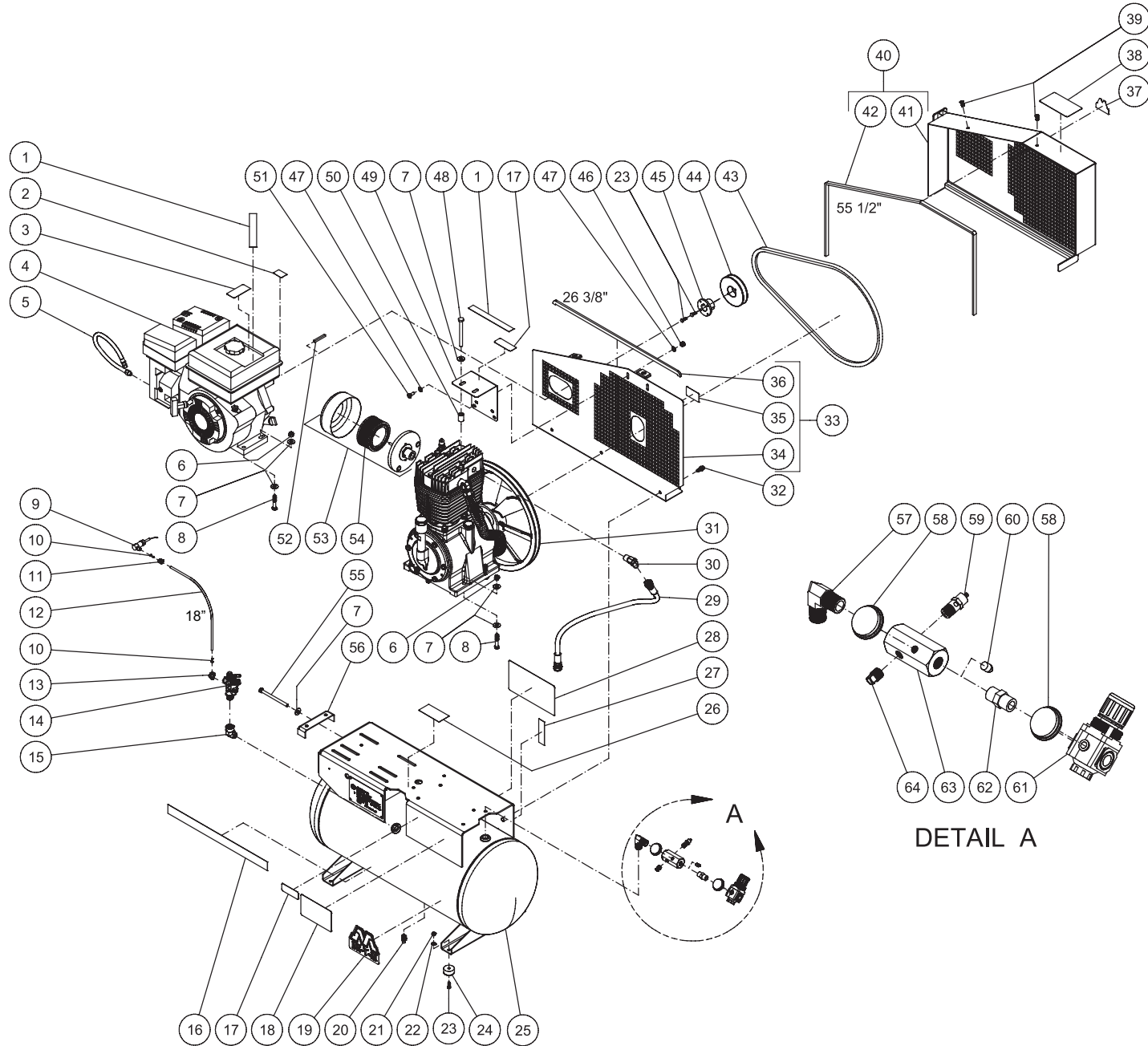

AM2-SR09-20M-031612-MLK

AM2-SR09-20M TANK ASSEMBLY

ITEM	DESCRIPTION	PART #	QTY	ITEM	DESCRIPTION	PART #	QTY
1	DECAL - CHECK OIL (SEE 71-0086)	N/A	2	34	BELTGUARD BACK	6-0093A01	1
2	DECAL - ENGINE FUEL (SEE 71-0086)	N/A	1	35	DECAL - BELTGUARD IN PLACE (SEE 71-0086)	N/A	1
3	DECAL - MUFFLER HOT (SEE 71-0086)	N/A	1	36	EDGING *(THREE FEET REQUIRED)	33-0020	1
4	ENGINE - SUBARU	1-0134	1	37	DECAL - Mi-T-M	34-2167	1
5	HOSE	70-0380	1	38	DECAL - OPERATING INSTRUCTIONS (SEE 71-0086)	N/A	1
6	LOCKNUT	30-0159	8	39	FASTENER	33-0197	2
7	WASHER	28-0023	19	40	BELTGUARD COVER ASSEMBLY (INC. 41-42)	854-0067	1
8	BOLT	27-0121	8	41	BELTGUARD FRONT	6-0094A51	1
9	AIR THROTTLE CONTROL	33-0394	1	42	EDGING *(FIVE FEET REQUIRED)	33-0020	1
10	TUBE SUPPORT	23-0486	2	43	BELT	11-0062	1
11	NUT	23-0315	1	44	SHEAVE	10-0039	1
12	HOSE *(TWO FEET REQUIRED)	15-0238	1	45	BUSHING	9-0005	1
13	ELBOW	23-0316	1	46	LOCKNUT	30-0157	2
14	PILOT VALVE	22-0270	1	47	WASHER	28-0003	4
15	ELBOW	24-0041	1	48	BOLT	27-8071	2
16	DECAL - STRIPE	34-2189	1	49	BRACKET	13-0189A01	1
17	DECAL - RISK OF BURNS (SEE 71-0086)	N/A	2	50	SPACER	33-0425	2
18	DECAL - MAINTENANCE INSTRUCTIONS (SEE 71-0086)	N/A	1	51	BOLT	27-0066	2
19	DECAL - Mi-T-M	34-2169	1	52	KEY	43-0078	1
20	PETCOCK	23-0312	1	53	FILTER CANISTER	19-0237	1
21	LOCKNUT	30-0155	4	54	AIR FILTER	19-0226	1
22	WASHER	28-0002	4	55	BOLT	27-0133	1
23	BOLT	27-0015	6	56	TIGHTENER BRACKET	20-0650A01	1
24	ISOLATOR	14-0069	4	57	ELBOW	24-0267	1
25	TANK	12-0192A01	1	58	PRESSURE GAUGE	22-0271	2
26	DECAL - SILVER STICKER	N/A	1	59	PRESSURE RELIEF VALVE	22-0267	1
27	DECAL - TANK DRAIN (SEE 71-0086)	N/A	1	60	PLUG	24-0082	1
28	DECAL - CAUTION/WARNING/DANGER (SEE 71-0086)	N/A	1	61	REGULATOR	22-0231	1
29	HOSE	15-0243	1	62	NIPPLE	24-0010	1
30	ELBOW	24-0074	1	63	MANIFOLD	24-0266	1
31	PUMP	3-0298	1	64	PLUG	24-0009	1
32	BOLT	27-9524	3	-	DECAL SET	71-0086	1
33	BELTGUARD BACK ASSEMBLY (INC. 34-36)	854-0066	1	*MUST ORDER IN ONE FOOT LENGTHS			

TANK ASSEMBLY FOR AM2-SR09-30M

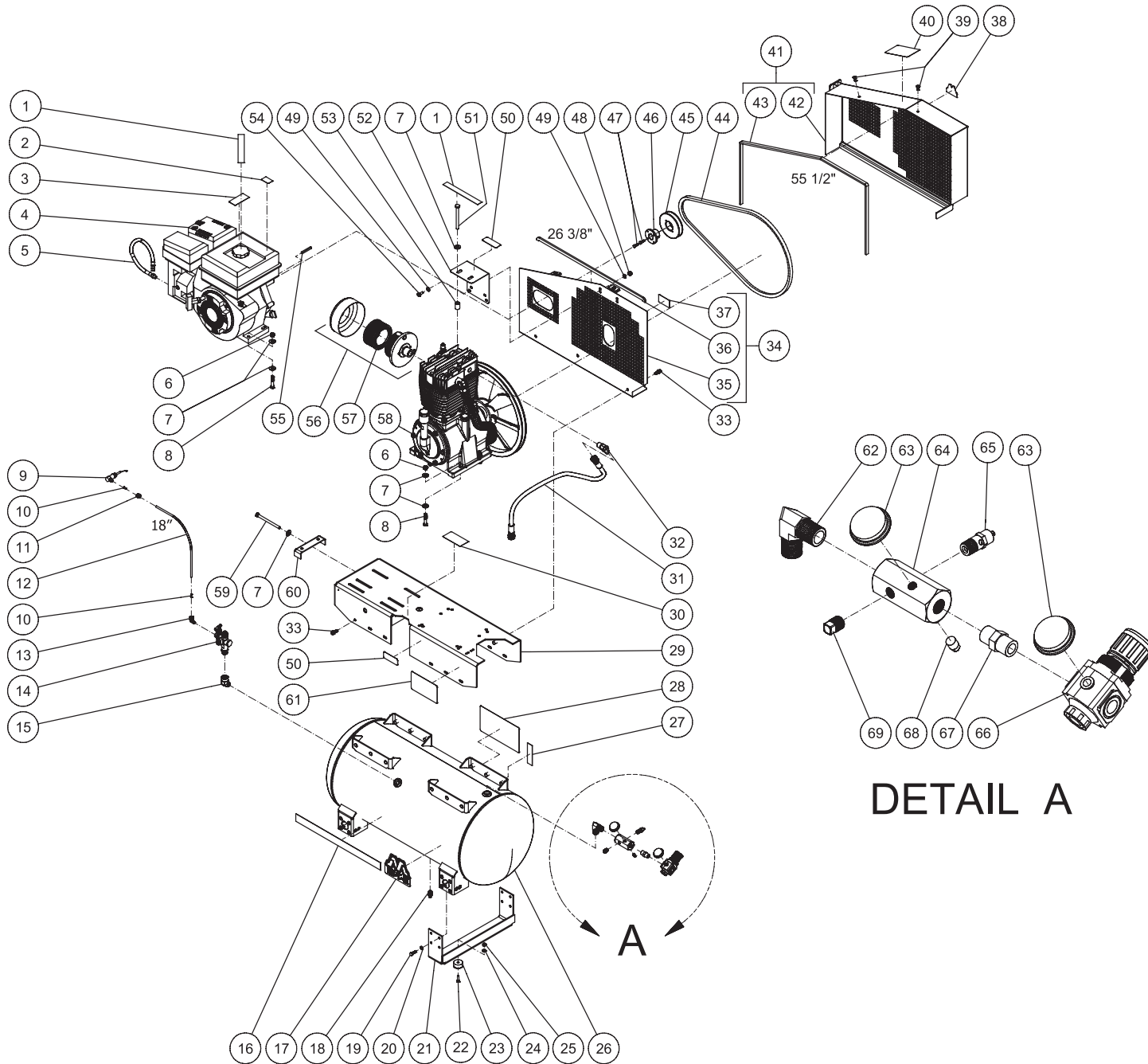

DETAIL A

AM2-SR09-30M-031612-MLK

AM2-SR09-30M TANK ASSEMBLY

ITEM	DESCRIPTION	PART #	QTY	ITEM	DESCRIPTION	PART #	QTY
1	DECAL - CHECK OIL (SEE 71-0086)	N/A	2	36	EDGING (THREE FEET REQUIRED)	33-0020	1
2	DECAL - ENGINE FUEL (SEE 71-0086)	N/A	1	37	DECAL - BELTGUARD IN PLACE (SEE 71-0086)	N/A	1
3	DECAL - MUFFLER HOT (SEE 71-0086)	N/A	1	38	DECAL - Mi-T-M	34-2167	1
4	ENGINE	1-0134	1	39	FASTENER	33-0197	2
5	HOSE	70-0380	1	40	DECAL - OPERATING INSTRUCTIONS (SEE 71-0086)	N/A	1
6	LOCKNUT	30-0159	8	41	BELTGUARD COVER ASSEMBLY	854-0067	1
7	WASHER	28-0023	19	42	BELTGUARD FRONT	6-0094A01	1
8	BOLT	27-0121	8	43	EDGING (FIVE FEET REQUIRED)	33-0020	1
9	AIR THROTTLE CONTROL	33-0394	1	44	BELT	11-0066	1
10	TUBE SUPPORT	23-0486	2	45	SHEAVE	10-0039	1
11	NUT	23-0315	1	46	BUSHING	9-0005	1
12	HOSE *(TWO FEET REQUIRED)	15-0238	1	47	BOLT	27-0015	2
13	ELBOW	23-0316	1	48	LOCKNUT	30-0157	2
14	PILOT VALVE	22-0270	1	49	WASHER	28-0003	4
15	ELBOW	24-0041	1	50	DECAL - RISK OF BURNS (SEE 71-0086)	N/A	2
16	DECAL - STRIPE	34-2189	1	51	BOLT	27-8071	2
17	DECAL - Mi-T-M	34-2169	1	52	BRACKET	13-0189A01	1
18	PETCOCK	23-0312	1	53	SPACER	33-0425	2
19	BOLT	27-0067	16	54	BOLT	27-0066	2
20	LOCKWASHER	29-0007	16	55	KEY	43-0078	1
21	SUPPORT FOOT BRACKET	20-0671A01	2	56	FILTER CANISTER	19-0237	1
22	BOLT	27-0016	4	57	AIR FILTER	19-0226	1
23	ISOLATOR	14-0069	4	58	PUMP	3-0298	1
24	WASHER	28-0002	4	59	BOLT	27-0133	1
25	LOCKNUT	30-0155	4	60	TIGHTENER BRACKET	20-0650A01	1
26	TANK	12-0193A01	1	61	DECAL - MAINTENANCE INSTRUCTIONS (SEE 71-0086)	N/A	1
27	DECAL - TANK DRAIN (SEE 71-0086)	N/A	1	62	ELBOW	24-0267	1
28	DECAL - CAUTION/WARNING/DANGER (SEE 71-0086)	N/A	1	63	PRESSURE GAUGE	22-0271	2
29	BASEPLATE	5-0197A01	1	64	MANIFOLD	24-0266	1
30	DECAL- SILVER STICKER	N/A	1	65	PRESSURE RELIEF VALVE	22-0267	1
31	HOSE	15-0243	1	66	REGULATOR	22-0231	1
32	ELBOW	24-0074	1	67	NIPPLE	24-0010	1
33	BOLT	27-9524	15	68	PLUG	24-0082	1
34	BELTGUARD BACK ASSEMBLY	854-0066	1	69	PLUG	24-0009	1
35	BELTGUARD BACK	6-0093A01	1	-	DECAL SET	71-0086	1

BASE MOUNT ASSEMBLY FOR AM2-SH09-B

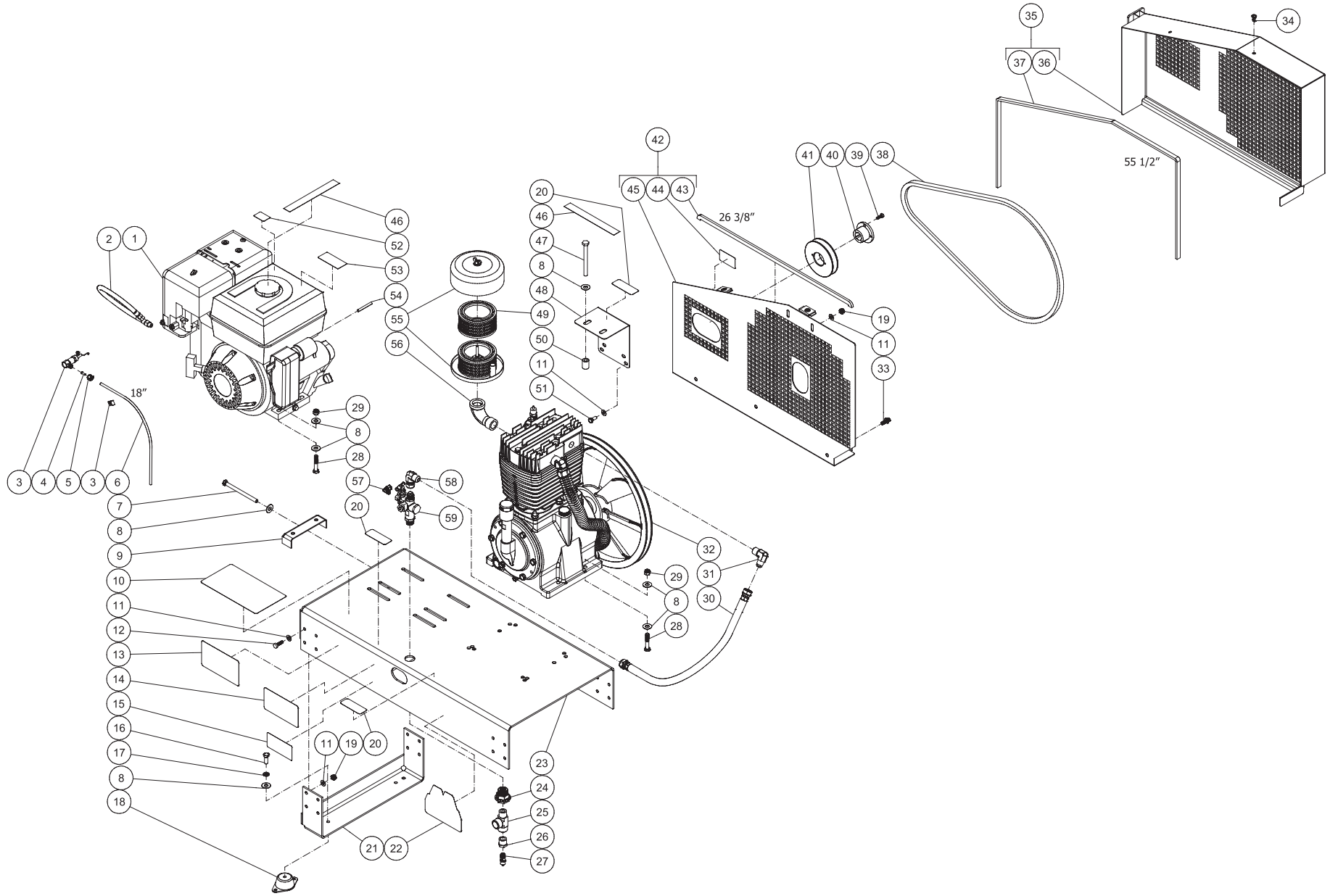

AM2-SH09-B 030912-MLK

AM2-SH09-B

ITEM	DESCRIPTION	PART #	QTY	ITEM	DESCRIPTION	PART #	QTY
1	ENGINE	1-0161	1	31	ELBOW	24-0074	1
2	OIL DRAIN HOSE	70-0358	1	32	PUMP	3-0298	1
3	THROTTLE CONTROL	33-0413	1	33	BOLT	27-9524	3
4	TUBE SUPPORT	23-0486	1	34	FASTENER	33-0197	2
5	NUT	23-0315	1	35	BELTGUARD COVER ASSEMBLY	854-0067	1
6	HOSE *(TWO FEET REQUIRED)	15-0238	1	36	BELTGUARD FRONT	6-0094A01	1
7	BOLT	27-0133	1	37	EDGING (FIVE FEET REQUIRED)	33-0020	1
8	WASHER	28-0023	23	38	BELT	11-0066	1
9	TIGHTENER BRACKET	20-0650A01	1	39	BOLT	27-0015	2
10	DECAL - CAUTION/WARNING/DANGER (SEE 71-0086)	N/A	1	40	BUSHING	9-0005	1
11	WASHER	28-0003	36	41	SHEAVE	10-0039	1
12	BOLT	27-0067	16	42	BELTGUARD BACK ASSEMBLY	854-0066	1
13	DECAL - MAINTENANCE INSTRUCTIONS (SEE 71-0086)	N/A	1	43	EDGING (THREE FEET REQUIRED)	33-0020	1
14	DECAL - OPERATING INSTRUCTIONS (SEE 71-0086)	N/A	1	44	DECAL - BELTGUARD IN PLACE (SEE 71-0086)	N/A	1
15	DECAL- DATA PLATE	N/A	1	45	BELTGUARD BACK	N/A	1
16	BOLT	27-0117	4	46	DECAL - CHECK OIL (SEE 71-0086)	N/A	2
17	LOCKWASHER	29-0008	4	47	BOLT	27-8071	2
18	ISOLATOR	14-0109	4	48	BRACKET	13-0189A01	1
19	LOCKNUT	30-0157	18	49	AIR FILTER	19-0226	1
20	DECAL - RISK OF BURNS (SEE 71-0086)	N/A	3	50	SPACER	33-0425	2
21	SUPPORT FOOT BRACKET	20-0671A01	2	51	BOLT	27-0066	2
22	DECAL - Mi-T-M	34-2169	1	52	DECAL - ENGINE FUEL (SEE 71-0086)	N/A	1
23	BASEPLATE	5-0252A01	1	53	DECAL - MUFFLER HOT (SEE 71-0086)	N/A	1
24	ADAPTER	23-0365	1	54	KEY	43-0078	1
25	STREET TEE	24-0242	1	55	FILTER CANISTER	19-0237	1
26	REDUCER	23-0056	1	56	ELBOW	23-0088	1
27	PRESSURE RELIEF VALVE	22-0267	1	57	ELBOW	23-0316	1
28	BOLT	27-0121	8	58	ELBOW	24-0272	1
29	LOCKNUT	30-0159	8	59	PILOT VALVE	22-0270	1
30	HOSE	15-0243	1	-	DECAL SET	71-0086	1

TWO STAGE COMPRESSOR (3-0298)

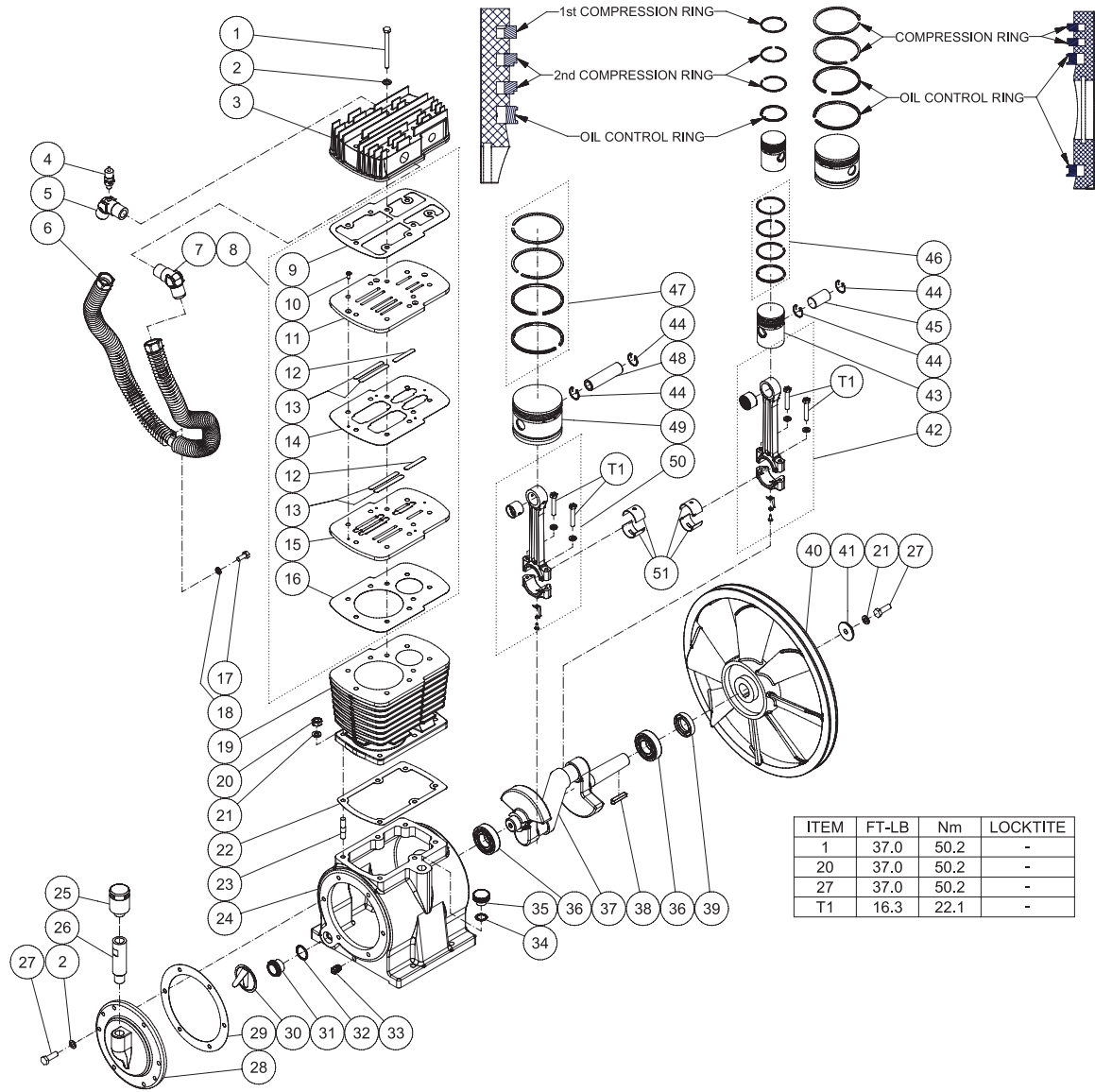

ITEM	FT-LB	Nm	LOCKTITE
1	37.0	50.2	-
20	37.0	50.2	-
27	37.0	50.2	-
T1	16.3	22.1	-

3-0298 021114 JDK

PUMP ASSEMBLY

ITEM	DESCRIPTION	PART #	QTY				
1	BOLT	27-8043	9		27	BOLT	27-8061 7
2	COPPER WASHER	28-1059	15		28	REAR CRANKCASE COVER	46-1278 1
3	CYLINDER HEAD	46-1272	1		29	GASKET - REAR CRANKCASE COVER	N/A 1
4	LP SAFETY VALVE	22-0362	1		30	OBSTRUCT OIL NET	46-1279 1
5	65° OUTLET ELBOW W/PORT	24-0304	1		31	OIL LEVEL SIGHT GLASS	46-1280 1
6	INTERCOOLER TUBE	46-1273	1		32	O-RING	25-0150 1
7	65° OUTLET ELBOW	24-0305	1		33	PLUG	24-0009 1
8	KIT - VALVE PLATE ASSY - (INC. 9-16)	70-0473	1		34	O-RING	25-0160 1
9	GASKET - VALVE PLATE (UPPER)	N/A	1		35	OIL FILL CAP	46-1281 1
10	SCREW	N/A	4		36	BALL BEARING	48-0024 2
11	UPPER VALVE SEAT	N/A	1		37	PUMP CRANKSHAFT	46-1282 1
12	HP VALVE REED	N/A	2		38	KEY	43-0125 1
13	LP VALVE REED	N/A	4		39	OIL SEAL	26-0302 1
14	GASKET - VALVE PLATE (MIDDLE)	N/A	1		40	FLYWHEEL	10-0139 1
15	LOWER VALVE SEAT	N/A	1		41	WASHER	N/A 1
16	GASKET - VALVE PLATE (LOWER)	N/A	1		42	KIT - HP CONNECTING ROD ASSEMBLY (INC. 49)	70-0468 1
17	BOLT	27-8032	1		43	PISTON	46-1283 1
18	LOCKWASHER	29-0054	1		44	PISTON SNAP RING	46-1284 4
19	CYLINDER	46-1274	1		45	PISTON PIN	46-1285 1
20	NUT	30-7203	6		46	KIT - HP PISTON RING	70-0469 1
21	LOCKWASHER	29-0055	7		47	KIT - LP PISTON RING	70-0470 1
22	GASKET - CYLINDER	N/A	1		48	PISTON PIN	46-1286 1
23	STUD	27-8991	6		49	PISTON	46-1287 1
24	PUMP CRANKCASE	46-1275	1		50	KIT - LP CONNECTING ROD ASSY (INC. 49)	70-0471 1
25	BREATHER ASSY	46-1276	1		51	CONNECTING ROD BUSHING	46-1288 4
26	BREATHER PIPE	46-1277	1		-	KIT - PUMP GASKET - (INC. 9, 14, 16, 20, 27)	70-0472 1

PILOT VALVE (22-0270)

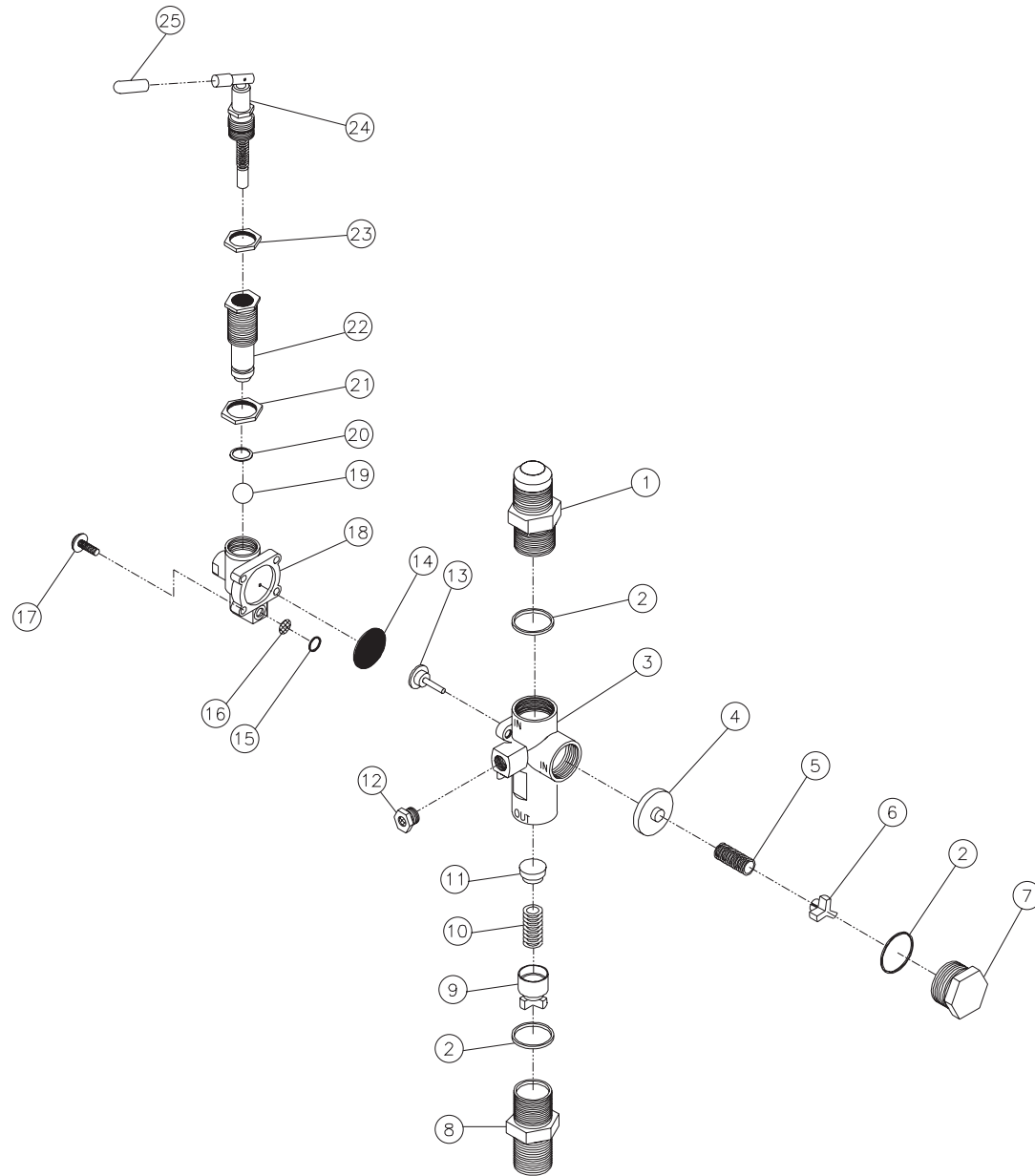

22-0270-062905-DLG

PILOT VALVE (22-0270)			
REF #	DESCRIPTION	PART #	QTY
1	Inlet Port Fitting	N/A	1
2	O-ring (See 70-0241)	N/A Sep.	3
3	Main Body	N/A	1
4	Piston Assembly-Unloader Valve (See 70-0241)	N/A Sep.	1
5	Spring-Unloader Valve (See 70-0241)	N/A Sep.	1
6	Spring Seat-Unloader Valve	N/A	1
7	Cap	N/A	1
8	Discharge Port Fitting	N/A	1
9	Spring Seat Assembly-Check Valve	N/A	1
10	Spring-Check Valve (See 70-0241)	N/A Sep.	1
11	Piston-Check Valve (See 70-0241)	N/A Sep.	1
12	Muffler	23-0419	1
13	Stem Unloader (See 70-0241)	N/A Sep.	1
14	Diaphragm (See 70-0241)	N/A Sep.	1
15	O-ring (See 70-0241)	N/A Sep.	1
16	Screen (See 70-0241)	N/A Sep.	1
17	Screw w/Washer	N/A	4
18	Pilot Body	N/A	1
19	Ball (See 70-0241)	N/A Sep.	1
20	O-ring (See 70-0241)	N/A Sep.	1
21	Differential Adjusting Locknut	N/A	1
22	Differential Adjusting Nut	N/A	1
23	Pressure Adjusting Locknut	N/A	1
24	Pressure Adjusting Toggle Assembly (See 70-0241)	N/A Sep.	1
25	Red Toggle Cover	N/A	1
	Repair Kit (Includes 4-5, 10-11, 13-16, 19-20, 24 and 3 each 2)	70-0241	

Manufactured by Mi-T-M
8650 Enterprise Drive, Peosta IA 52068
563-556-7484/ Fax 563-556-1235